

COMPACT LOW DIFFERENTIAL PRESSURE SWITCHES

Set Points from 0.07 to 20 in w.c. Repetitive Accuracy within 3%

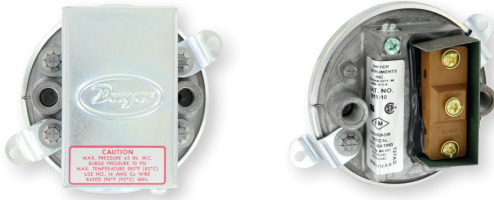

Series 1910 switch with conduit enclosure off. Shows electric switch and set point adjustment screw located on same side for easy installation.

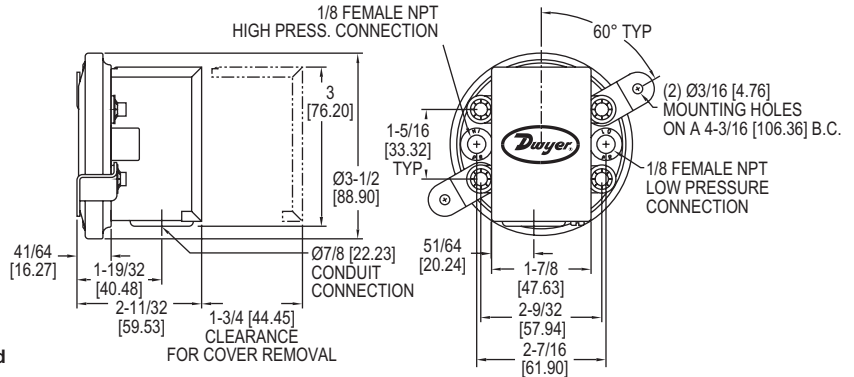

The Dwyer-engineered force-motion amplifier increases the leverage of diaphragm movement and results in a switch with excellent sensitivity and repeatability.



Our most popular **Series 1900 Compact Low Differential Pressure Switches** combine advanced design and precision construction to make these switches able to perform many of the tasks of larger, costlier units. Designed for air conditioning service, they also serve many fluidics, refrigeration, oven and dryer applications. Series 1900 switches have set points from 0.07 to 20 in w.c. (1.8 to 508 mm). Set point adjustment is easy with range screw located inside conduit enclosure. Internal location helps prevent tampering. UL, CE and CSA listed, and FM approved. For use with air or compatible gases.

FEATURES/BENEFITS

- Compact size and repeatability, provides a high-value switch for many industrial and OEM applications
- Wide range of models from 0.07 in w.c. to 20 in w.c. can meet exacting OEM specifications for a low pressure switch
- Range screw protected inside enclosure provides simplifies making adjustments but prevents tampering

APPLICATIONS

- Air conditioning refrigeration coil icing detection; defrost cycle initiation
- Clogged filter detection
- Variable air volume controller

Model	Operating Range in w.c.	Approximate Deadband	
		At Min. Set Point	At Max. Set Point
1910-00	0.07 to 0.15	0.04	0.04
1910-0	0.15 to 0.5	0.10	0.10
1910-1	0.40 to 1.6	0.15	0.16
1910-5	1.40 to 5.5	0.30	0.30
1910-10	3.0 to 11.75	0.40	0.40
1910-20	4.0 to 20.0	0.40	0.50

ACCESSORIES	
Model	Description
A-399	Duct pressure monitor kit; for use with standard or manual reset model switches; includes mounting flange, tubing and adapters
A-329	Street ell; brass adapter for applications requiring right angle connections; two required for differential pressures
A-302F-A	303 SS static pressure tip with mounting flange; for 3/16" ID rubber or plastic tubing; 4" insertion depth; includes mounting screws
A-489	4" straight static pressure tip with flange

SPECIFICATIONS	
Service: Air and non-combustible, compatible gases.	Electrical Connections: 3 screw type, common, normally open and normally closed.
Wetted Materials: Consult factory.	Process Connections: 1/8" female NPT.
Temperature Limits: -30 to 180°F (-34 to 82.2°C).	Mounting Orientation: Diaphragm in vertical position. Consult factory for other position orientations.
Pressure Limits: 45 in w.c. (11.2 kPa) continuous, 10 psig (68.95 kPa) surge.	Set Point Adjustment: Screw type inside conduit enclosure.
Switch Type: Single-pole double-throw (SPDT).	Weight: 1 lb 4.5 oz (581 g).
Repeatability: ±3%.	Agency Approvals: CE, CSA, FM, and UL. Optional-EXPL explosion-proof enclosure does not possess any agency approvals.
Electrical Rating: 15 A @ 120-480 VAC, 60 Hz. Resistive 1/8 HP @ 125 VAC, 1/4 HP @ 250 VAC, 60 Hz. Derate to 10 A for operation at high cycle rates.	

OPTIONS	
Weatherproof Housing	
16 ga. steel enclosure with gasketed cover (NEMA 4, IP66) for wet or oily conditions. Withstands 200 hour salt spray test. Wt. 5-1/2 lb (2.5 kg). Switch must be factory installed.	
Note: To order, change 1910 base number to 1911, add -WP suffix. Example: 1911-1-WP	
Explosion-Proof Housing	
Cast iron base with brass cover. Rated Class I, Groups D; Class II, Div. 2, Groups E, F, G; Class III and NEMA 7, 9 NEMA 3. (7 lb). Switch must be factory installed.	
Note: To order, change 1910 base number to 1911, add -EXPL suffix. Example: 1911-1-EXPL	
Manual Reset Option (Model 1900 MR)	
Includes special snap switch which latches on pressure increase above the setpoint. Switch must be manually reset after pressure drops below the setpoint. Available on -1, -5, -10 or -20 ranges only. Option is not UL, CSA or FM listed. For use only in single positive pressure applications.	
Note: To order, change 1910 base number to 1900, add -MR suffix. Example: 1900-10-MR	



Manual reset option

USA: California Proposition 65
⚠️WARNING: Cancer and Reproductive Harm - www.P65Warnings.ca.gov

Process Tubing Options: See page 455 (Gage Tubing Accessories)