

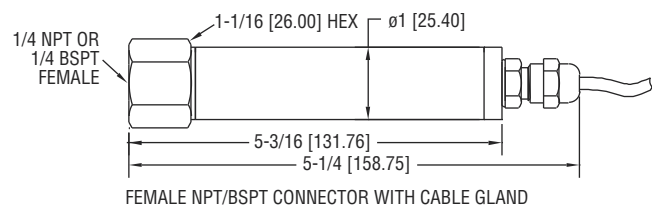

## Series IS626 Pressure Transducer

## Specifications - Installation and Operating Instructions

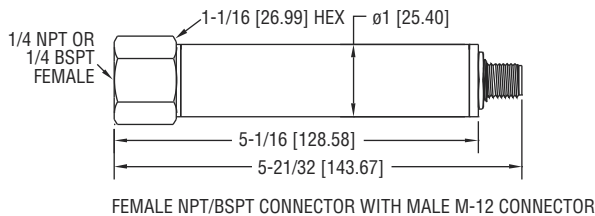
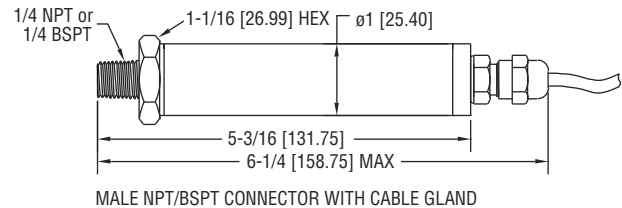
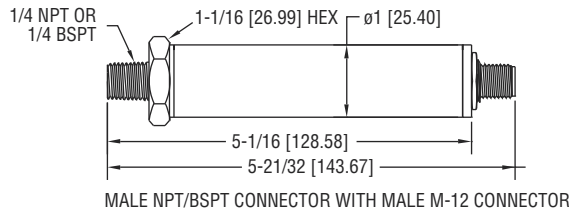

CD = CRITICAL DIMENSION  
STANDARD TOLERANCES UNLESS NOTED:  
ALL DECIMAL DIMENSIONS ± .005  
ALL ANGLES ± 1°

The Dwyer Series IS626 Pressure Transducer convert pressure into a standard 4-20 mA output signal. The Series IS626 can be used to accurately measure compatible gases and liquids. Series IS626 full scale accuracy is 0.25% (see specifications). Designed for industrial environments with a NEMA 4X (IP66) housing, this transmitter resists most effects of shock and vibration.

#### Intrinsic Safety Approval Classification

The IS626 is UL listed for use in Hazardous (Classified) Locations. The protection method is by Intrinsic Safety, "ia". It was investigated by UL under UL Standard 913 8th Edition, CAN/CSA C22.2 No. 60079-0:15 and CAN/CSA C22.2 No. 60079-11:14.

Hazardous (Classified) Location Intrinsically Safe For:

Class I Div. 1 Groups A,B,C,D  
Class II Div. 1 Groups E,F,G  
Class III Div. 1

Class I Zone 0 AEx ia IIC T4 Ga  
Zone 20 AEx ia IIIC T135°C Da  
Ex ia IIC T4 Ga  
Ex ia IIIC T135°C Da  
Ta = -20°C to 80°C

Install in accordance with Control Drawing 001833-42.

See Control Drawing 001833-42 for Entity Parameters.

ATEX: EU TYPE CERTIFICATE NO. DEMKO 18 ATEX 2080

ATEX STANDARDS: EN 60079-0:2012/A11:2013

EN 60079-11:2012

ATEX CLASSIFICATION: **CE** 2813 **Ex** II 1 G Ex ia IIC T4 Ga (-20°C ≤ Tamb ≤ 80°C)

**CE** 2813 **Ex** II 1 D Ex ia IIIC T135°C Da (-20°C ≤ Tamb ≤ 80°C)

IECEX CERTIFICATE OF CONFORMITY: IECEX UL 18.0086

IECEX STANDARDS: IEC 60079-0: 2011 6TH ED.

IEC 60079-11:2011 6TH ED.

IECEX CLASSIFICATION: Ex ia IIC T4 Ga (-20°C ≤ Tamb ≤ 80°C)

Ex ia IIIC T135°C Da (-20°C ≤ Tamb ≤ 80°C)

INSTALL IN ACCORDANCE WITH CONTROL DRAWING 001833-45

SEE CONTROL DRAWING 001833-45 FOR ENTITY PARAMETERS.

#### SPECIFICATIONS

**Service:** Compatible gases and liquids.

**Wetted Materials:** Type 316, 316L SS.

**Accuracy:** 0.25% FS (includes linearity, hysteresis, and repeatability).

**Temperature Limit:** -4 to 176°F (-20 to 80°C).

**Compensated Temperature Range:** -4 to 176°F (-20 to 80°C).

**Thermal Effect:** ±0.02% FS/°F (includes zero and span).

**Pressure Limits:** 2X FS.

**Power Requirements:** 10-28 VDC.

**Output Signal:** 4-20 mA.

**Response Time:** 50 msec.

**Loop Resistance:** 0 -900 Ω max.

**Current Consumption:** 38 mA (max).

**Electrical Connections:** 3 ft. cable or 4-pin M-12 connector.

**Process Connection:** 1/4" male/female NPT and BSPT.

**Enclosure Rating:** NEMA 4X (IP66) (Self declared by Dwyer Instruments, Inc.).

**Mounting Orientation:** Mount in any position.

**Weight:** 8.9 oz (252 g).

**Agency Approvals:** CE, See Intrinsic Safety Approval Classification.



**WARNING:** Use with approved safety barriers using entity evaluation.

Aluminum tag must be removed prior to installation for all units supplied with aluminum tag option Suffix "AT".



**CAUTION:** Do not exceed specified supply voltage ratings. Permanent damage not covered by warranty will result. This device is not designed for 120 or 240 volt AC operation. Use only on 10-28 VDC.

## INSTALLATION

**1. Location:** Select a location where the temperature of the transducer will be between -4 and 176°F (-20 to 80°C). Distance from the receiver is limited only by total loop resistance. The tubing or piping supplying pressure to the unit can be practically any length required but long lengths will increase response time slightly.

**2. Position:** The transducer is not position sensitive. However all standard models are originally calibrated with the unit in a position with the pressure connection downward. Although they can be used at other angles, for best accuracy it is recommended that units be installed in the position calibrated at the factory.

**3. Pressure Connection:** Use a small amount of plumber's tape or other suitable sealants to prevent leaks. Be sure the pressure passage inside the port is not blocked.

## 4. Electrical Connections

**Wire Length** - The maximum length of wire connecting the transducer and receiver is a function of wire size and receiver resistance. Wiring should not contribute more than 10% of the receiver resistance to total loop resistance. For extremely long runs (over 1000 feet), choose receivers with higher resistance to minimize the size and cost of connecting leads. Where wiring length is under 100 feet, wire as small as 22 AWG can be used.

## 5. Wiring

An external power supply delivering 10-28 VDC with minimum current capability of 40 mA DC (per transducer) is required to power the control loop. See Figure A for connection of the power supply, transducer and receiver. The range of appropriate receiver load resistance (RL) for the DC power supply voltage available is expressed by the formula:

$$R_{L \max} = \frac{V_{ps} - 12.3V}{20 \text{ mA}}$$

Shielded cable is recommended for control loop wiring.

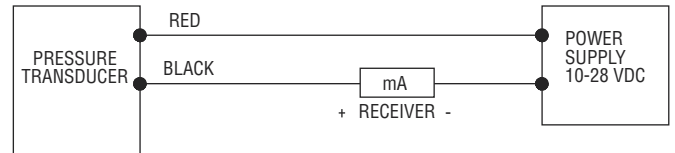

Figure A

When using cable version IS626, black wire is negative (-) and red wire is positive (+). When using 4-pin M-12 connector models, wire to pins as shown below in Figure B.

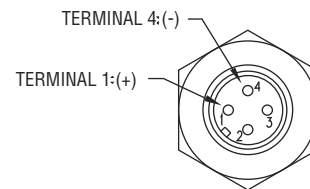
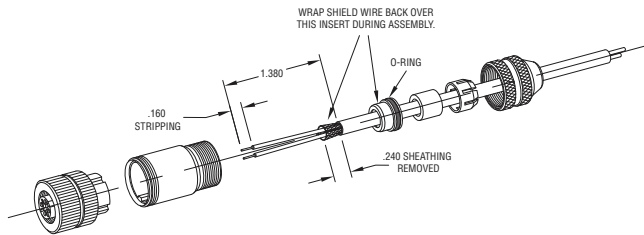

Figure B: Male-12 connector

## ACCESSORIES

### A-295 Female M-12 Connector

A female 4 position M-12 connector for use in connecting to the M-12 male connector on the IS626. Fit 0.16" to 0.29" diameter cables with a maximum wire gage at 18 AWG (0.75 mm<sup>2</sup>).



ACCESSORY A-295

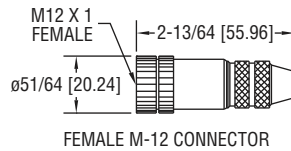

### A-231 Shielded Cable

A pre-made 16.4 ft (5 m) cable with a 4 pin Female M-12 connector is available for use when connecting to the male M-12 connector on the IS626. Black wire is negative and the brown wire is positive.

## MAINTENANCE

After final installation of the pressure transducer and its companion receiver, no routine maintenance is required. A periodic check of system calibration is suggested. The Series IS626 transducers are not field repairable and should be returned if repair is needed (field repair should not be attempted and may void warranty). Be sure to include a brief description of the problem plus any relevant application notes. Contact customer service to receive a return goods authorization number before shipping.

- NOTES:
1. SELECTED ASSOCIATED APPARATUS MUST BE THIRD PARTY LISTED AS PROVIDING INTRINSICALLY SAFE CIRCUITS FOR THE APPLICATION, AND NOT EXCEED THE ENTITY PARAMETERS LISTED IN THIS DRAWING.
  2. ASSOCIATED APPARATUS OUTPUT CURRENT MUST BE LIMITED BY A RESISTOR SUCH THAT THE OUTPUT VOLTAGE-CURRENT PLOT IS A STRAIGHT LINE DRAWN BETWEEN OPEN-CIRCUIT VOLTAGE AND SHORT-CIRCUIT CURRENT.
  3. CAPACITANCE AND INDUCTANCE OF THE FIELD WIRING FROM THE INTRINSICALLY SAFE TRANSDUCER TO THE ASSOCIATED APPARATUS SHALL BE CALCULATED AND MUST BE INCLUDED IN THE SYSTEM CALCULATIONS AS SHOWN IN THIS DRAWING.
  4. TRANSDUCERS MUST BE INSTALLED TO THE MANUFACTURER'S CONTROL DRAWING AND ARTICLE 504 OF THE NATIONAL ELECTRICAL CODE (ANSI/NFPA 70) FOR INSTALLATION IN THE UNITED STATES OR SECTION 78 OF THE CANADIAN ELECTRICAL CODE (CSA C22.1) FOR INSTALLATION IN CANADA OR OTHER LOCAL INSTALLATION CODES, AS APPLICABLE.
  5. THE ASSOCIATED APPARATUS MANUFACTURER'S INSTALLATION INSTRUCTIONS MUST BE FOLLOWED WHEN INSTALLING THE EQUIPMENT.
  6. NO REVISIONS TO THIS DRAWING WITHOUT PRIOR APPROVAL BY UL.

HAZARDOUS AREA  
CLASS I, DIV.1  
ZONE 0  
ZONE 20  
IIC  
IIC

NON-HAZARDOUS AREA

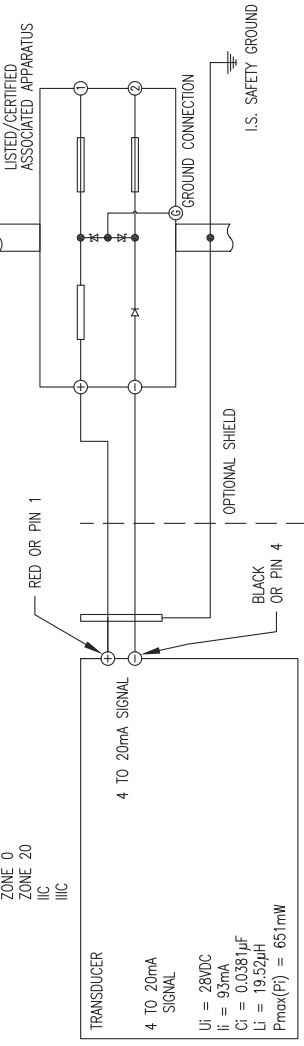

HAZARDOUS (CLASSIFIED) LOCATION INTRINSICALLY SAFE FOR:

- CLASS I DIV.1 GROUPS A,B,C,D
- CLASS II DIV.1 GROUPS E,F,S
- CLASS III DIV.1
- CLASS I ZONE 0 AEx ia IIC T4 Ga
- ZONE 20 AEx ia IIC T135°C Da
- Ex ia IIC T4 Ga
- Ex ia IIC T135°C Da
- To = -20°C TO 80°C

ASSOCIATED APPARATUS

- Voc (Vo) ≤ 28V
- Isc (Io) ≤ 93mA
- Po (Po) ≤ 0.651W
- Ca (Co) ≥ 0.0381µF + C cable
- La (Lo) ≥ 19.52µH + L cable

STANDARDS:  
AS REFERENCE BY UL 913 - 8th EDITION CAN/CSA C22.2 NO. 60079-0:15  
UL 60079-0 - 6th EDITION CAN/CSA C22.2 NO. 60079-11:14  
UL 60079-11 - 6th EDITION

- IS626-00-GH-bb-cf-51-d
  - BLANK OR AT(ALUM TAG) AND/OR NIST(NIST CAL CERT) OPTIONS
  - S1(4-20 mA) OUTPUT CONFIGURATION
  - E1(3FT CABLE), E2(6FT CABLE), E3(9FT CABLE), OR E6(BENDIX CONN.) ELECTRICAL CONNECTION
  - P1(1/4 MNPT), P2(1/4 FNPT), OR P3(1/4 MBSPT) PROCESS FITTING
  - GH(GENERAL PURPOSE SS) HOUSING
- TWO NUMERIC CHARACTERS 06 THRU 14, 22, 24, 25, OR 27 SENSOR RANGE

Ⓢ = CRITICAL DIMENSION  
UNLESS OTHERWISE NOTED:  
ALL DIMENSIONS IN INCHES  
ALL ANGLES ± 1°

|   |  |          |  |                      |  |
|---|--|----------|--|----------------------|--|
| DATE  |  | NAME     |  | MATERIAL             |  |
| 02-09-18  |  | IS626    |  | I.S. CONTROL DRAWING |  |
| DRAWN BY  |  | CHECKED  |  | FINISH               |  |
| AMS   |  | AMS      |  |                      |  |
| CHG   |  | CHG      |  |                      |  |
| DOH   |  | DOH      |  |                      |  |
| BY/DATE   |  | APPROVED |  |                      |  |
| 02-28-18  |  | LR       |  |                      |  |
| CHANGES   |  | ACAD002  |  |                      |  |
| NO.   |  | 3        |  |                      |  |
| <p>NOTE: This drawing and the principal and alternate views embodied therein are the intellectual property of Dwyer Instruments, Inc. and shall not be reproduced, stored in a retrieval system, or transmitted in any form or by any means, without the written consent of said corporation.</p> |  |          |  |                      |  |
| <p>ZONE AND DIVISION ENTITY PARAMETERS ARE SHOWN AS: DIVISION (ZONE)</p>  |  |          |  |                      |  |

**Dwyer Instruments, Inc.**  
MICHIGAN CITY, INDIANA 46360 U.S.A.

FR. NO. 001833-42

- NOTES:
1. SELECTED ASSOCIATED APPARATUS MUST BE THIRD PARTY LISTED AS PROVIDING INTRINSICALLY SAFE CIRCUITS FOR THE APPLICATION, AND NOT EXCEED THE ENTITY PARAMETERS LISTED IN THIS DRAWING.
  2. CAPACITANCE AND INDUCTANCE OF THE FIELD WIRING FROM THE INTRINSICALLY SAFE TRANSDUCER TO THE ASSOCIATED APPARATUS SHALL BE CALCULATED AND MUST BE INCLUDED IN THE SYSTEM CALCULATIONS AS SHOWN IN THIS DRAWING.
  3. THE ASSOCIATED APPARATUS MANUFACTURER'S INSTALLATION INSTRUCTIONS MUST BE FOLLOWED WHEN INSTALLING THE EQUIPMENT.
  4. WARNING - ALL FIELD WIRING SHALL BE SUITABLE FOR AN AMBIENT TEMPERATURE RANGE OF -20° TO 80°C.
  5. NO REVISIONS TO THIS DRAWING WITHOUT PRIOR APPROVAL BY UL/DENKO.
  6. TRANSDUCER MUST BE INSTALLED IN ACCORDANCE TO IEC/EN 60079-14 OR ANY LOCAL INSTALLATION CODES/REQUIREMENTS.

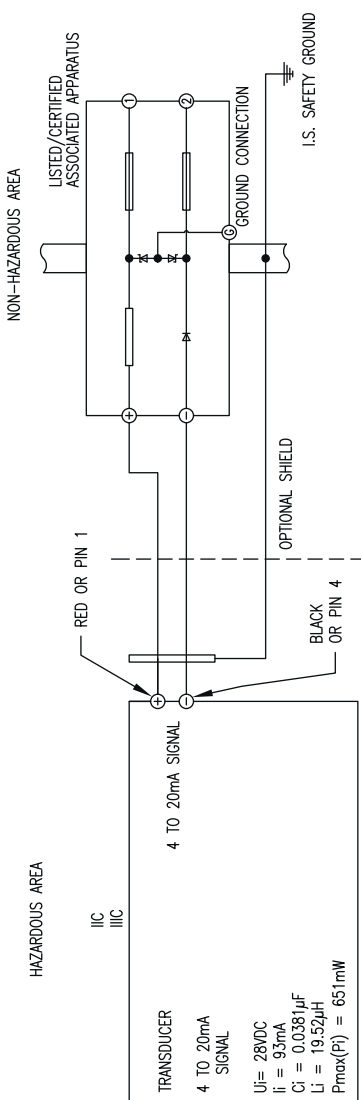

HAZARDOUS AREA

IIC T4 Ga (-20°C ≤ Tamb ≤ 80°C)

TRANSDUCER

4 TO 20mA SIGNAL

4 TO 20mA SIGNAL

I= 93mA

I= 93mA

CI = 0.0381µF

LI = 19.52µH

Pmax(Pi) = 651mW

NON-HAZARDOUS AREA

LISTED/CERTIFIED ASSOCIATED APPARATUS

GROUND CONNECTION

I.S. SAFETY GROUND

OPTIONAL SHIELD

RED OR PIN 1

BLACK OR PIN 4

ATEX CLASSIFICATION: Ex ia IIC T4 Ga (-20°C ≤ Tamb ≤ 80°C)

IECEx CLASSIFICATION: Ex ia IIC T4 Ga (-20°C ≤ Tamb ≤ 80°C)

ATEX STANDARDS: EN 60079-0:2012/A11:2013  
EN 60079-11:2012

IECEx STANDARDS: IEC 60079-0:2011 6TH ED.  
IEC 60079-11:2011 6TH ED.

ASSOCIATED APPARATUS

Voc (Vc) ≤ 28V

Isc (Ib) ≤ 93mA

Po (Po) ≤ 0.651W

Ca (Ca) ≥ 0.0381µF + C cable

La (La) ≥ 19.52µH + L cable

- IS626-00-GH-bb-cs-S1-ATEX-d
  - L BLANK OR AT(ALUM TAG) AND/OR NIST(NIST CAL CERT) OPTIONS
  - L ATEX (ATEX/IECEx COMPLIANT) CONFIGURATION
  - L S1(4-20 mA) OUTPUT CONFIGURATION
  - L E1(3FT CABLE), E2(6FT CABLE), E3(9FT CABLE), OR E6(BENDIX CONN.) ELECTRICAL CONNECTION
  - L P1(1/4 MNPT), P2(1/4 FNPT), OR P3(1/4 MBSPT) PROCESS FITTING
  - L GH(GENERAL PURPOSE SS) HOUSING
- L TWO NUMERIC CHARACTERS 06 THRU 14, 22, 24, 25, OR 27 SENSOR RANGE

ZONE AND DIVISION ENTITY PARAMETERS ARE SHOWN AS: DIVISION (ZONE)

| NO. | CHANGES  | BY/DATE  | LR   |
|-----|--|----------|------|
| 2   | ADDED ATEX CONFIGURATION PER ECR #045704           | 12-10-19 | AMS  |
| 1   | GENERAL REVISION AS REQUESTED BY UL PER ECR #13410 | 6-20-18  | CHKD |
| 0   | INITIAL RELEASE NP-005145                          | 02-28-18 | DGH  |
|     |  |          | APPD |

| DATE     | NAME |
|----------|------|
| 02-14-18 |      |

| MATERIAL |
|----------|
| FINISH   |

| IS626                |
|----------------------|
| I.S. CONTROL DRAWING |
| ATEX/IECEx           |

| FR. NO.   | 3 |
|-----------|---|
| 001833-45 |   |

⊕ = CRITICAL DIMENSION  
TOLERANCES UNLESS NOTED:  
STANDARD DIMENSIONS ± .305  
ALL ANGLES ± 1°

NOTICE: This drawing and the principles and elements of design embodied therein are the exclusive property of DWYER INSTRUMENTS, INC. and are not to be reproduced, copied, or used in any form without the prior written consent of DWYER INSTRUMENTS, INC. and must not be submitted to outside parties for commission without the written consent of said corporation.

DWYER INSTRUMENTS, INC.  
MICHIGAN CITY, INDIANA 46360 U.S.A.





