



# DPM Particulate Monitoring Systems

**DPM Control Units  
PMS Sensors**

## **INSTALLATION & OPERATING MANUAL**



---

Dwyer Instruments, Inc.

102 Indiana Highway 212  
P.O. Box 373  
Michigan City, IN 46361 USA  
Telephone 800-872-9141  
[www.dwyer-inst.com](http://www.dwyer-inst.com)

## I. Technical Support & Return Procedure

Dwyer Instruments, Inc. provides industry leading technical support for all product lines. The technical support department is staffed with a team of engineering professionals.

Areas of assistance provided by the Technical Support department include:

- Pre-Installation Site Analysis
- Product Installation
- General Operation
- Application Specific
- Routine Calibration
- EPA Compliance
- Performance Upgrades and Add-On Features

To ensure the best and most efficient technical support please be prepared with the following information prior to contacting Dwyer Instruments, Inc. If it is determined that the component must be returned for evaluation/repair, a Return Material Authorization number will be issued. You must include the RMA number on the packing slip and mark the outside of the shipping container.

- Company Name \_\_\_\_\_
- Product Model Number \_\_\_\_\_
- Product Serial Number \_\_\_\_\_
- Date of Installation \_\_\_\_\_
- Reason for Return \_\_\_\_\_

Dwyer Instruments Technical Support may be reached by:

Phone: (800) 872-9141

Fax: (219) 872-9057

E-Mail: [tech@dwyer-inst.com](mailto:tech@dwyer-inst.com)

Hours of Operation: 8AM – 5PM Central Standard Time

- Any control unit or particulate sensor that was exposed to hazardous materials in a process must be properly cleaned in accordance with OSHA standards and a Material Safety Data Sheet (MSDS) completed before it is returned to the factory.
- All shipments returned to the factory must be sent by prepaid transportation.
- All shipments will be returned F.O.B. factory.
- Returns will not be accepted without a Return Material Authorization number.

## II. Notifications

**This document contains important information necessary for proper operation of the product. It is strongly urged that all users of the product read this manual in its entirety. All instructions should be followed properly and any questions that arise should be discussed with Dwyer Instruments, Inc.**

**Any use or distribution of this document without the express consent of Dwyer Instruments, Inc. is strictly prohibited. Any reproduction is prohibited without written permission.**

**In no event will Dwyer Instruments, Inc. be liable for any mistake, including lost profits, lost savings, environmental compliance costs or other incidental or consequential damages arising out of the use or inability to use this manual, even if advised of the possibility of such damages, or any claim by any other party.**

---

### WARNING



Identifies information about practices or circumstances that can lead to personal injury or death, property damage, or economic loss.

Warning statements help you to:

- Identify a hazard
- Avoid a hazard
- Recognize the consequences

### IMPORTANT

Identifies information that is critical for successful application and understanding of the product.

---



Identifies information, sections or statements in this manual that apply to approved hazardous area systems, regulations or installation.

---

### III. Approvals and Certifications



#### CE Conformant

The Control Units and Particulate Sensors conform to the appropriate country standards and governing regulations listed below:

- EN 61010/1993 “Safety requirements for electrical equipment for measurement, control and laboratory use.”
- EN 55011/1991 “Limits and methods of measurement of radio interference characteristics of industrial, scientific and medical equipment”. Class A: Industrial and commercial.
- EN50082-1/1993 “Electromagnetic compatibility – Generic immunity standard”. Part 1: Residential, commercial and light industry.



#### CSA Certified

This Particulate Monitoring system is certified by the Canadian Standards Association (to US and Canadian Standards) for use in hazardous locations as specified below:

##### Particulate Sensor:

##### **Intrinsically Safe for Hazardous Locations**

PMS-AHZ1 Intrinsically Safe Particulate Sensor in the following areas:

Class I, Division 1, Groups A, B, C, and D

Class II, Division 1, Groups E, F, G

Class III

For use with the Control Units listed below, 70°C maximum ambient.

**Note:** There is no temperature rise caused by electrical components. Temperature code is based only on ambient temperature, (e.g. a 200°C process requires a T3 rating.)

##### Control Unit:

##### **For use in Ordinary Locations Only**

DPM-AHZ1 Control Unit rated 115 Vac/230 Vac, 0.1A or 24Vdc, 0.25A, -25°C to 70°C, with intrinsically-safe output to Particulate Sensor.

DPM-AHZ1 Control Unit - Approved for use with PMS-AHZ1 sensors, where the PMS-AHZ1 sensor is the only component located in the hazardous area.

## IV. Specifications

CONTROL UNIT			
PARAMETER	DETAIL	SPECIFICATION	NOTE
Input Voltage	115V~	97–132V~, 47–63Hz Fuse: 0.032A, Slo-Blo 250V, Type 'T' Fuse: 0.050A, Slo-Blo 250V, Type 'T' when Self Check Option is installed	Selector Switch to 115V
	230V~	195–264V~, 47–63Hz Fuse: 0.032A, Slo-Blo 250V, Type 'T' Fuse: 0.050A, Slo-Blo 250V, Type 'T' when Self Check Option is installed	Selector Switch to 230V
	24VDC	22–26VDC Fuse: 0.250A, 250V, Type 'T'	No Selector Switch Optional Model
Input Power		6 Watts Max.	
Measurement Units		picoamperes (pA)	$1 \times 10^{-12}$ Amp
Detection Level/Range	Standard	5.0pA – 5000pA	
	Optional	0.5pA – 5000pA	
Electronic Accuracy		± 5% of Range, std ± 1% of Range, optional	Over Full Temp Range
Temperature Range	Operating	-13°F to +160°F (-25°C to +70°C)	
	Storage	-40°F to +185°F (-40°C to +85°C)	
Relay Outputs	Type	Form A (SPST)	
	Rating	5A @ 240V~ Resistive **Customer must provide a 8A (maximum) fuse in series with relay load.	
4-20mA Output (Optional)	Type	Isolated	
	Rating	470Ω Max. Loop Impedance	
	Span	Adjustable Via Keypad	Default: 1000pA LOG
RS-485 Network (Optional)	Type	Isolated, Multi-drop, ½ Duplex	
	Settings	19,200 BPS, 8 Data Bits, 1 Stop Bit, No Parity	Modbus/RTU Protocol
Enclosure	Type	Painted Cast Aluminum NEMA 4X or optional CSA Approved Enclosure	Other optional
PARTICULATE SENSOR			
Mounting	NPT	½" NPT Thread	Other optional
	QC	1.5" Quick-Clamp (Mounting ferrule is 1" NPT)	
	FL	ANSI Flange (2", 150# is typical)	
	Other	Others Available	
Materials	Probe	Stainless Steel With Protective Teflon Layer	
	Nipple/Mount	Stainless Steel	
Process Temperature Range	Operating	-40°F to +250°F (-40°C to +120°C)	
		-40°F to +450°F (-40°C to +232°C)	
		-40°F to +800°F (-40°C to +426°C)	
		> 800°F	Higher Optional
Ambient Temperature Range	Operating	-40°F to +160°F Maximum (-40°C to +70°C) Maximum Must be Calculated for each application	T-Code Ratings for AHZ1 option only
Pressure Range	Operating	Full Vacuum to 10PSI (2.11kg/cm <sup>2</sup> )	Higher Optional
Enclosure	Type	Painted Cast Aluminum	Other - Consult Factory
	Rating	NEMA 4X (IP 66)	Other - Consult Factory

<b>PARTICULATE SENSOR CABLE</b>			
<b>PARAMETER</b>	<b>DETAIL</b>	<b>SPECIFICATION</b>	<b>NOTE</b>
Type		High Quality Coaxial	
Temperature Range	Operating	-40°F to +392°F (-40°C to +200°C)	
Maximum Length		300 ft.	
<b>DETECTION LEVEL/RESOLUTION AND APPLICATION RANGE</b>			
Approximate Particulate Concentration	5.0pA Standard	At least 5.0 – 5000 mg/m <sup>3</sup> At least 0.002 to 2.0 gr/ft <sup>3</sup>	Barely Visible to Visible >5% Opacity Moderate Dilute Flow
	0.5pA Upgrade	At least 0.5 to 5000 mg/m <sup>3</sup> At least 0.0002 to 0.2 gr/ft <sup>3</sup>	Invisible to Barely Visible, < 5% Opacity Light Dilute Flow
Velocity Range		150 ft/min. (45.7 m/min.) and Higher	
Particle Size Range		0.3 Micron and higher If <10.0 Micron, 0.5pA Detection Required	

## V. Installation Drawings

<b>Drawing Number</b>	<b>Sheets</b>	<b>Description</b>
225-1016-01	2	Particulate Monitor Installation Drawings
225-1014-06	1	Particulate Flow Sensor Installation Drawing, All Mounts
225-1036	1	High Temperature / High Pressure Particulate Flow Sensor Installation Drawing
<b>Hazardous Area Control Drawing</b>		
225-1005	1	Hazardous Area Control Drawing

---

**TABLE OF CONTENTS**

<b>1. Safety</b> .....	<b>2</b>
1.1 Applicable Use.....	2
1.2 General.....	2
1.3 Hazardous Area Systems.....	3
<b>2. Introduction</b> .....	<b>4</b>
<b>3. Control Unit Installation</b> .....	<b>5</b>
3.1 Location.....	5
3.2 Wiring.....	5
3.3 Grounding.....	6
<b>4. Particulate Sensor Installation</b> .....	<b>7</b>
4.1 Location.....	7
4.2 Mounting.....	8
4.3 Sensor Temperature Considerations.....	9
<b>5. Particulate Sensor Coaxial Cable Installation</b> .....	<b>10</b>
<b>6. Control Unit Operation</b> .....	<b>12</b>
6.1 User Interface Overview.....	12
6.2 Menu 1 Setup.....	13
6.3 Menu 2 Setup.....	14
6.4 Menu 3 Setup.....	16
6.5 Long Term Averaging.....	17
6.6 4-20mA Analog Output Scaling.....	18
6.7 Interpreting Particulate Readings for Fabric Filter Applications.....	20
6.8 Alarm Levels for Fabric Filter Applications.....	22
<b>7. Manual System Zero Check</b> .....	<b>23</b>
<b>8. Automatic Self Checks</b> .....	<b>26</b>
8.1 Control Unit Hardware Check.....	26
8.2 Control Unit Zero Check.....	27
8.3 Control Unit Span Check.....	28
8.4 Sensor Cable Check.....	28
8.5 Particulate Sensor Check.....	28
8.6 Process Running Signal.....	29
8.7 Monitoring Self Check Status.....	29
8.8 Particulate Alarming During Self Checks.....	30
8.9 Self check Recording.....	30
<b>9. Troubleshooting</b> .....	<b>31</b>
<b>10. Routine Maintenance</b> .....	<b>31</b>
<b>11. Spare Parts</b> .....	<b>32</b>
<b>12. Appendix</b> .....	<b>33</b>
12.1 Modbus®/RTU RS-485 Networking Protocol.....	34
12.2 Ethernet/IP® Networking.....	37



# 1. Safety

## 1.1 Applicable Use

These particulate monitor systems are not designed for use as a functional safety device and do not carry a SIL rating. The device must not be used as part of a safety system or as an input signal to a safety system. These monitors are designed for general process and environmental monitoring.

## 1.2 General

This apparatus is available with various agency approvals as noted in the approvals section. All versions of this device have been designed to comply with EN 61010, safety requirements for electrical equipment for measurement, control and laboratory use, and are supplied in a safe condition. Before beginning an installation the following safety precautions and all precautions noted listed throughout this manual and in the installation drawings must be followed.

---

### WARNING



### AREA CLASSIFICATION

- Before installing any device confirm area classification requirements. Do not install any device that is not tagged as suitable for the required area classification.

### PROCESS AND AMBIENT CONDITIONS

- Before installing any device, confirm ambient temperature, process temperature and process pressure requirements. Do not install any device that is not tagged as suitable for the required temperatures and pressures. Confirm compatibility of the wetted and non-wetted materials.

### INSTALLATION PERSONNEL AND SERVICE

- Only appropriately licensed and trained professionals should perform the mechanical and electrical installation.
- This device does not contain field serviceable components other than the line fuse. Only factory personnel can perform service on this equipment.
- For operator safety and to prevent ignition of flammable or combustible atmospheres always disconnect power before servicing.

### GROUNDING AND FUSING

- Before turning on the instrument, you must connect the protective earth terminal of the instrument to a proper earth ground. Grounding to the neutral conductor of a single-phase circuit is not sufficient protection.
- Only fuses with the required current, voltage and specified type should be used. Do not use repaired fuses or short-circuited fuse holders.

### REGULATORY CODES

- Installation and operation must adhere to all national and local codes.
-

### 1.3 Hazardous Area Systems

Systems approved for use in hazardous areas include nameplates indicating that they are suitable for installation in hazardous areas. The nameplate lists allowable hazardous areas and T code ratings as well as approval agency markings. Do not install any device that is not tagged as suitable for the area classification.

Sections or statements in this manual that apply to approved hazardous area systems or installations are designated with the following symbol. Designation for use in hazardous areas does not make the system suitable for use as a functional safety device.



---

**WARNING****EXPLOSION HAZARD**

- Hazardous area control drawing 225-1005 must be followed for proper installation.
  - Installation must be in accordance with ANSI/ISA RP12.6 and National Electric Code ANSI/NFPA 70, Article 504
  - Substitution of components may impair intrinsic safety.
  - Do not connect or disconnect components unless power has been disconnected.
  - Designation for use in hazardous areas does not make the system suitable for use as a functional safety device.
- 



## 2. Introduction

A Particulate Monitoring System consists of a control unit, a particulate sensor and a sensor coaxial cable. Applications include continuous emissions monitoring, baghouse filter leak detection and process particulate flow monitoring. Types of particulate include both solid particulates (dusts, powders, granulars and pellets) and liquid particulates (mists). Various control unit models and sensors are provided to match the application and process monitoring needs.

### Principle of Operation

Particulate Monitoring Systems employ a highly reliable technology based on induction. A sensor probe is mounted in an airflow stream such as a pipe, duct or stack (for small tubing an inline non-intrusive ring sensor is employed). As particulate flows near and over the sensing element, minute electrical currents are induced in the sensor and transferred to the control unit by a coaxial cable. A microprocessor filters and processes the signal into a normalized, absolute output that is linear to the mass concentration of particulate.

---

#### **IMPORTANT** MASS CORRELATION

It is important to note that the above relation between instrument units (pA) and actual mass ( $\text{mg}/\text{m}^3$  or  $\text{gr}/\text{cf}$ ) is just an approximate guide for selecting the appropriate model and range and for providing a general indication of the typical particulate levels monitored. For a true correlation between (pA) and actual mass ( $\text{mg}/\text{m}^3$  or  $\text{gr}/\text{cf}$ ), a gravimetric correlation such as an isokinetic sample must be performed for each application and a recommended model and detection level must be ordered. It is also important to note that the accuracy of such correlations is application dependent and produces the best results with consistent particulate and process conditions. The user must follow proper procedures and must understand the typical accuracy of such correlation techniques. Consult factory for details.

---

### Control Unit

The control unit (i.e. electronics) is housed in a rugged cast aluminum enclosure. An LCD displays particulate levels in bar-graph and digital forms. A lockable membrane keypad is provided for setup and adjustment. An optional self check sub system is available to automatically verify calibration and operation of the control unit, sensor and cable. Various relay, analog inputs and outputs, as well as serial communications are available in the control unit.

### Particulate Sensor

The particulate sensor is very rugged and virtually maintenance-free. The sensor is passive with no active circuits for high reliability and durability. It does not require special alignment and is not affected by normal vibration.

### Coaxial Cable for Particulate Sensor

The cable that connects the particulate sensor to the control unit is a high-quality coaxial cable specifically designed for the system. Maximum length is 300 ft (91m). **Do not use substitute cable.**

## 3. Control Unit Installation

### 3.1 Location

The following factors should be considered when determining the control unit location:

- Locate at a position that is convenient for setup and operation
- Mount at eye level
- Mount to a flat surface in a vertical orientation
- Do not mount to surfaces with excessive heat or vibration

---

**WARNING****INSTALLATION PERSONNEL**

- Only appropriately licensed professionals should install this product.
- For operator safety and to prevent ignition of flammable or combustible atmospheres always disconnect power before servicing.

**WARNING****CONTROL UNIT LOCATION**

- The control unit may only be located in ordinary locations (non-hazardous safe areas).
- Do not locate the control unit in a hazardous area unless it is inside an appropriately rated explosion-proof or purged enclosure and supplied as part of an approved hazardous area system with approved control unit and approved sensor assembly.
- Do not locate the control unit in or near sources of very high electrical noise such as a Variable Frequency Drive (VFD) or Motor Control Center. Locate the control unit at least 10 feet from these sources and, if possible, power the control unit from a separate power source. If power is supplied from the same branch circuit or a circuit containing electrical noise, install a quality line filter such as an Islatrol IC+102.

---

**Mounting:** Mounting holes are integrated into the enclosure base. Mounting hardware should be capable of supporting five times the control unit weight. Refer installation drawings for dimensions.

### 3.2 Wiring

An appropriately licensed electrician must perform all electrical connections.

---

**WARNING****CONTROL UNIT WIRING**

- All wiring must be rated 250V minimum.
  - The control unit must be mounted within sight of an appropriate electrical disconnect (on/off switch) to ensure safety during installation and maintenance.
  - The coaxial cable must be in conduit that is separate from all other circuits.
-

There are connections inside the control unit for the sensor coaxial cable, the power supply, relay contacts and optional 4-20mA or RS-485 outputs. Refer to the installation drawings.

Conduit openings are provided in the bottom of the enclosure to route wiring into the enclosure. Never drill new conduit openings in the side or top of the enclosure as a bad conduit seal may allow water to enter the enclosure.

### 3.3 Grounding

Proper grounding of the control unit is essential to ensure reliable operation and operator safety. When used as part of an approved hazardous area system two separate ground connections are required, protective ground and intrinsic safety ground. It is not sufficient to use a single ground connection and jumper the protective and intrinsic safety grounds inside the control unit enclosure.

---

#### WARNING



#### CONTROL UNIT GROUNDING

- Protective earth ground must be connected to terminal #1.
  - The enclosure cover must be bonded to the enclosure base with the supplied ground bonding wire – do not remove.
  - When used as part of an approved hazardous area system: Intrinsic safety ground must be connected to terminal #2 and must be less than 1 ohm with respect to earth ground. Refer to control drawing 225-1005.
  - When used as part of an approved hazardous area system: Intrinsic safety ground must utilize a grounding electrode independent of the protective earth ground.
-

## 4. Particulate Sensor Installation

### 4.1 Location

The following factors should be considered when determining the sensor location:

- Area Classification
- Flow conditions
- Electrical (Faraday) shielding
- Atmospheric shielding (in the case of ducts and stacks open to atmosphere)
- Access for installation and service

---

#### WARNING



#### SENSOR LOCATION

- Before installing the sensor, confirm area classification requirements. Do not install any device that is not tagged suitable for the required area classification.
- Before installing the particulate sensor, confirm ambient temperature, process temperature and process pressure requirements. Do not install any device that is not tagged as suitable for the required temperatures or pressures. Confirm compatibility of wetted and non-wetted materials.
- For hazardous areas, a maximum ambient temperature of the particulate sensor enclosure must not be exceeded. Refer to the Temperature Considerations section for full details.

---

It is essential for the pipe/duct to provide an electrical (Faraday) shield for the sensor. It is therefore required that the pipe, duct or stack is metal and earth grounded (small inline tubing sensors provide their own section of metal pipe which also must be grounded). Consult the factory when insertion probe style sensors are to be installed in non-conductive pipes, ducts such as plastic or fiberglass.

The particulate sensor must be installed in a position where the flow is reasonably laminar and the particulate is evenly distributed. The ideal position is where the pipe/duct is straight and free of items such as valves, dampers or other flow obstructions for a length of 4 diameters or longer. Horizontal or vertical sections are acceptable. For basic flow/no flow detection it is not necessary to select a location with a long straight section if access has to be sacrificed dramatically. For trending and measurement the need for a straight section and laminar flow increases. The particulate sensor should be positioned with approximately two thirds of the straight section upstream of the sensor and one third downstream. The particulate sensor should be located in the center of the pipe/duct. If the pipe/ducting is square it should be located in the center of one of the sides. In either case, be sure the position is such that the tip of the sensor reaches the midpoint or beyond. Always use good engineering sense and be sure the sensor will interact with a reasonable representation of the flow.

For emissions detection applications such as baghouses or cartridge collectors, good locations are generally found upstream of the blower. The particulate sensor can be located downstream of the blower but not too close to the stack outlet. There must be sufficient duct downstream of the sensor to provide adequate electrical and atmospheric shielding. The sensor should be located upstream of any sampling ports by at least two feet. It is not necessary that the sensor be in the same section of the duct/stack as the sampling ports. Particulate sampling ports require fully-developed laminar flow and longer straight sections.

Extreme vibration should be avoided.

---

**IMPORTANT****ATMOSPHERIC AND ELECTRICAL SHIELDING OF SENSOR**

- It is essential for the pipe/duct to provide an electrical (Faraday) shield for the sensor. The pipe/duct or stack should be metal with a high quality earth ground. Consult the factory for non-conductive pipes/ducts such as plastic or fiberglass. (Small in-line sensors for small tubing provide their own section of metal pipe, which also must be grounded).
  - When the sensor is placed in a stack/duct choose a location away from atmosphere so wind driven atmospheric particulate or rain does not flow over the sensor and so external electrical noise cannot affect operation.
  - Do not place the sensor where the pipe/duct is corroded or cracked which may allow water droplets to create signals as they flow by.
- 

## 4.2 Mounting

The following types of process mounts are available for the standard probe style sensors:

NPT, Quick-Clamp and ANSI flange.

Inline sensors for small tubing are supplied with swage lock or other tube connections to mount inline with metal or plastic tubing.

Installation drawings of each mounting type can be found in the appendix.

---

**WARNING****HAZARDOUS AREA SENSOR GROUNDING**

- For hazardous area applications an external sensor earth ground cable is required to maintain sensor grounding during installation and maintenance.
  - The ground cable must remain attached when the sensor is temporarily removed from the process – do not disconnect the ground cable.
  - Leave sufficient ground cable service loop for easy removal of the sensor from the process.
-

### 4.3 Sensor Temperature Considerations

The sensor may be ordered with one of three process temperature ranges:

1. -40°F to 250°F (-40°C to 121°C)
2. -40°F to 450°F (-40°C to 232°C)
3. -40°F to 800°F (-40°C to 426°C)
4. Consult Factory for Temperatures >800°F

Note: For the process temperatures in the range of 233°C - 426°C, a high temp probe must be used.

The maximum allowable ambient temperature at sensor housing is 70°C.

**Table: T Code Rating for Sensor**

Maximum Ambient	Process Temperature Does Not Exceed				
	75°C (167°F)	125°C (257°F)	225°C (437°F)	325°C (617°F)	426°C (800°F)
70°C (160°F)	T6	T4	T2C	T1*	T1*



## 5. Particulate Sensor Coaxial Cable Installation

**Connection:** Prior to making coaxial cable connections review the following routing instructions.

### IMPORTANT

#### PARTICULATE SENSOR COAXIAL CABLE ROUTING

- The sensor cable must be installed in conduit that is separate from all other wiring.
- The cable should be routed from the particulate sensor to the control unit in a path that avoids high vibration, heat over 394°F (200°C) and any strong magnetic or electrical fields.
- The cable should be located at least 18 in (46 cm) away from any power lines (conduit), motors, frequency drives and other sources of electrical interference throughout its entire path.
- The cable should be installed in metallic conduit. At the process end, use a section of shielded flex conduit that is 1 to 2 times the probe length to serve as a service loop.

The coaxial cable is connected to the control unit by a coax connector and is connected to the sensor by two ring terminals. The connectors are normally supplied pre-assembled to the cable.

Once the cable has been routed, insert the coax connector into the control unit enclosure leaving a very small service loop as specified in the installation drawing shown in the appendix. A larger service loop should be used at the sensor end, typically 1 to 2 times the sensor length. Any small amount of extra cable length should be pulled into the nearest junction box and NOT left in the sensor housing or in the control unit enclosure. If there is a significant amount of extra cable (many feet), the cable should be shortened at the sensor end and the sensor end connectors should be re-assembled using factory-supplied connectors and instructions.

### IMPORTANT

#### COAXIAL CABLE INSIDE THE CONTROL UNIT

- A ferrite suppressor is located on the sensor coaxial cable near the coax connector and must remain inside the control unit enclosure.
- The black cable insulation must extend a minimum of 6 in (15 cm) into the coax cable conduit.
- Do not leave any excess cable in the control unit or sensor housing.

Inside the particulate sensor enclosure, attach the coax cable as indicated in the sensor drawing. When connecting the braided shield, ensure it does not touch the surge voltage protection assembly. Do not leave excess cable inside the sensor housing.

**Sensor Test Port (Non-Hazardous Areas Only)**

**Location:** A test port should be installed in a negative pressure location. It must be located upstream of the sensor so particulate can flow very near and around the sensor. It should be located at least 3 ft (1 m) upstream of the sensor and it should be located on the same side of the duct as the sensor so particles can pass very near and around the sensor. If possible locate the test port at ground level.

**Mounting:** The test port is either screwed into a 1/8 inch NPT threaded hole, or welded in position. (Note: A foot or so of tubing can be connected to the nipple to make it easy to draw particles out of a container. Only a pinch of particulate at a time is needed for a response check.)

---

**IMPORTANT TEST PORT INSTALLATION**

- Installation of a sensor test port enables checking the response to an actual increase in particulate.
-

## 6. Control Unit Operation

### 6.1 User Interface Overview

The following drawing shows the user interface consisting of a four-button keypad and an LCD display. The LCD display has a scalable analog bar graph combined with a digital readout for ease in interpreting the dynamic readings, which are typical with particulate flow.

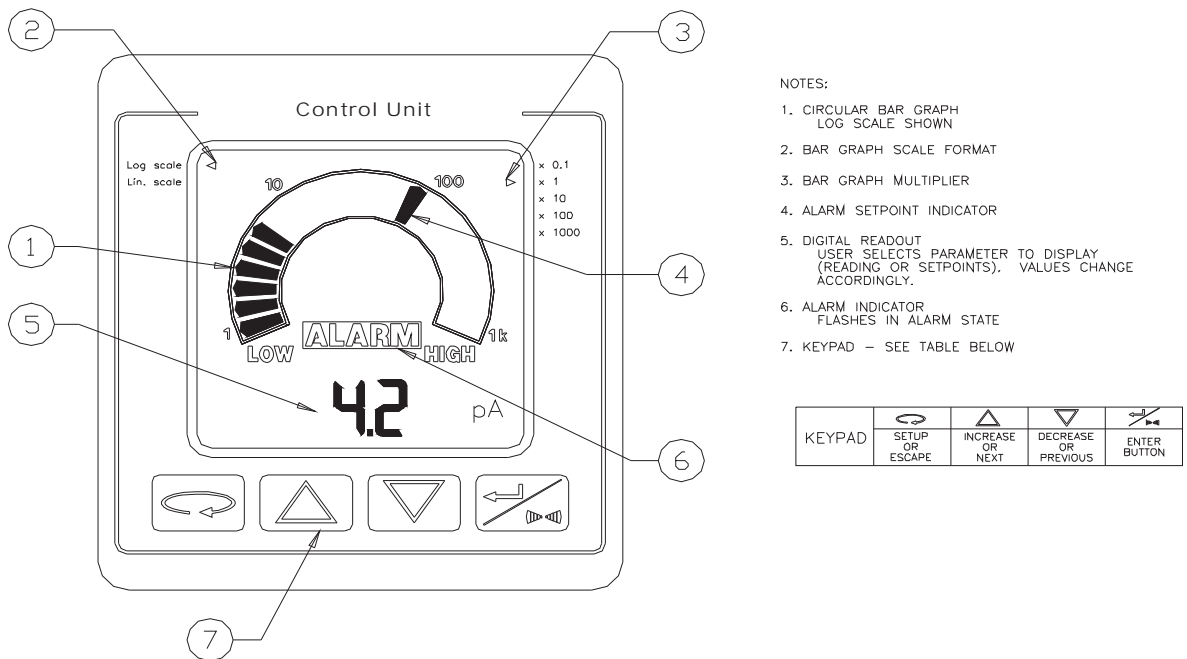

The control unit has two alarm relays which are individually activated when the reading continuously exceeds the alarm setpoint for the amount of time delay specified. Each is an SPST (FORM A) relay contact output.

Alarm logic may be set to Normal or Fail-safe mode. In Normal mode, the alarm relay contact is open under normal conditions and closes when the associated alarm is active. In Fail-safe mode, the alarm relay contact is closed under normal conditions and opens when the associated alarm is active, or when power to the control unit is removed.





When the reading exceeds the alarm setpoint, the alarm delay timer is started. As long as the reading remains above the alarm setpoint, the alarm delay timer will continue timing. If the reading drops below the alarm setpoint before the alarm delay timer expires, the alarm delay timer is reset. If the reading remains above the alarm setpoint and the alarm delay timer expires, an alarm is activated and the associated alarm relay contact will close (Normal logic) or open (Fail-safe logic).

If an alarm is activated and the reading drops below the alarm setpoint, the alarm is cleared and the alarm delay timer is reset. As described above, alarms will clear automatically and no operator acknowledgment is required.

Control units designed for powder flow applications include the ability to define a LOW alarm level that will activate when the particulate reading falls BELOW the setpoint. See Menu 1 Setup details.

### 6.2 Menu 1 Setup

Alarm setpoints are accessed through Menu 1 setup. To enter Menu 1, press the **SETUP** key. Setpoints may be modified by pressing the UP and DOWN arrow keys. Values are saved by pressing the ENTER key. To discard any changes made and return to the main screen, press the SETUP/ESCAPE key. Refer to the Menu 1 setup diagram below for menu navigation and allowable setpoint ranges. Features designated with an asterisk (\*) are optional. Operation of optional features is dependant upon model and options selected at the time of order. The following setup menus are based on firmware version 2.27 or higher.

			
SETUP or ESCAPE	INCREASE or NEXT	DECREASE or PREVIOUS	ENTER or ACCEPT



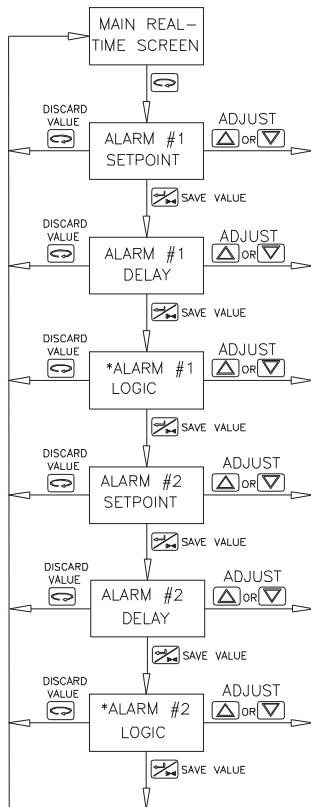

From the main screen, press the SETUP key to enter the Menu 1 setup screen. Use the UP/DOWN arrow keys to adjust settings to the desired values. Press the ENTER key when finished to save a value and proceed to next menu item. Press the SETUP/ESCAPE key to return to the main screen without saving the current parameter's value.



Menu Item	Range	Definition
Alarm #1 Relay #1 Setpoint	0-5000 pA	The alarm setpoint is compared to the process reading to determine alarm status. Relay #1 will close when alarm #1 is active and open when alarm #1 is cleared.
Alarm #1 Relay #1 Delay	1-600 Sec	Number of seconds the reading must exceed the alarm setpoint before alarm relay #1 contact will close.
* Alarm #1 Relay #1 Logic	HI/LO	Select the logic for the alarm. HI activates when the reading is above the setpoint. LO activates when the reading is below the setpoint.
Alarm #2 Relay #2 Setpoint	0-5000 pA	The alarm setpoint is compared to the process reading to determine alarm status. Relay #2 will close when alarm #2 is active and open when alarm #2 is cleared.
Alarm #2 Relay #2 Delay	1-600 Sec	Number of seconds the reading must exceed the alarm setpoint before alarm relay #2 contact will close.
* Alarm #2 Relay #2 Logic	HI/LO	Select the logic for the alarm. HI activates when the reading is above the setpoint. LO activates when the reading is below the setpoint.

### 6.3 Menu 2 Setup

Navigation within Menu 2 is similar to that described in Menu 1. Features designated with an asterisk (\*) are optional. Operation of optional features is dependant upon model and options selected at the time of order. The following setup menus are based on firmware version 2.27 or higher.

			
SETUP or ESCAPE	INCREASE or NEXT	DECREASE or PREVIOUS	ENTER or ACCEPT

Press the SETUP and ENTER keys at the same time from any main screen to enter the Menu 2 setup screen. Use the UP/DOWN arrow keys to adjust the setting to the desired value. Press the ENTER key to save the value and proceed to the next setup screen. Press the SETUP/ESCAPE key to return to the main screen without saving the current parameter's value.

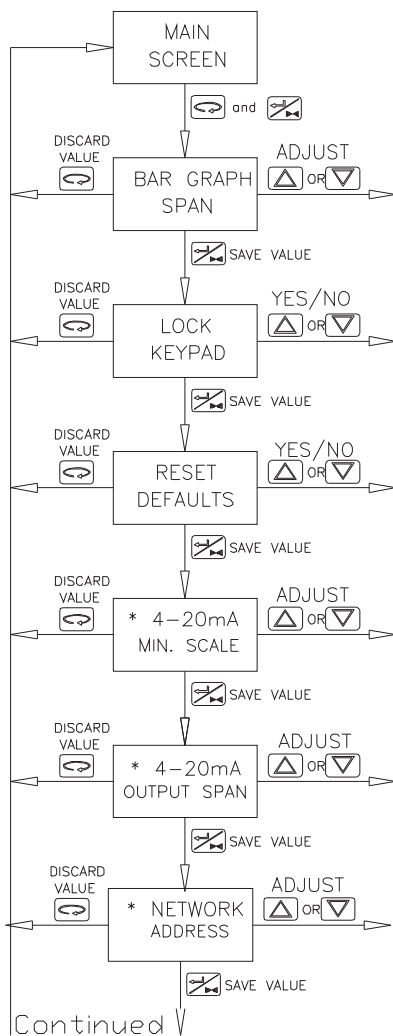



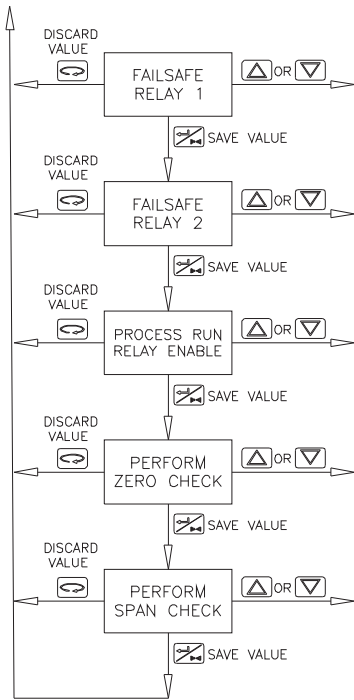

Menu Item	Range	Definition
Bar Graph Span	Automatic Linear Automatic Log 100,000 Log 10,000 Log 1,000 Log 100.0 Log 10,000 Linear 1,000 Linear 100.0 Linear 10.0 Linear 1.0 Linear	Allows the user to configure the full-scale span of the bar graph readout. The user may select a fixed scale, or a auto-ranging scale where the unit will select it's own scale automatically. The user can select between a LINEAR or LOGARITHMIC scale. (Log scaling is recommended for processes with dynamic, spiking readings such as a baghouse or cartridge type dust collector.)
Lock Keypad	No/Yes	Locks the keypad to prevent unauthorized modifications. Once locked, alarm levels cannot be viewed or modified until the keypad is unlocked. To unlock, enter Menu 2 and set the lock keypad parameter to NO.
Reset Defaults	No/Yes	Resets all alarm set points and user-adjustable parameters to their factory default values by selecting YES
* 4-20mA Minimum Scale	0.0 Linear 0.1 – 10.0 Log	Sets the 4mA value of the 4-20mA output. Entering "0.0" defines Linear scale. A value other than "0.0" defines logarithmic scale.
* 4-20mA Output Span	0 – 5,000 Linear 1 – 900,000 Log	Sets the 20mA value of the 4-20mA output. Linear span can be set to any value. Logarithmic span will also determine the number of decades. Example: Linear output: Min Scale=0.0, Output Span=1,000. 3-decade logarithmic output: Min Scale=1.0, Output Span=1,000.
* Network Address	1 - 32	Modbus®RTU slave address for the RS-485 serial network. Each device must have a unique address.



Fail-safe Relay 1	No/Yes	When set to "Yes", inverts the alarm relay logic. Relay is ON when NO alarm condition exists and is OFF when there IS an alarm condition. Relay is OFF when power is removed from the control unit.
Fail-safe Relay 2	No/Yes	When set to "Yes", inverts the alarm relay logic. Relay is ON when NO alarm condition exists and is OFF when there IS an alarm condition. Relay is OFF when power is removed from the control unit.
Process Run Relay Enable	No/Yes	When set to "Yes", enables use of the process run relay input channel. When set to "No", disables use of this input. Refer to Automated Self Checks section of the manual for details on use of this relay input.
* Perform Zero Check	No/Yes	When set to "Yes", triggers an automatic zero check. Refer to Automated Self Checks section of manual for full details.
* Perform Span Check	No/Yes	When set to "Yes", triggers an automatic span check. Refer to Automatic Self Checks section of manual for full details.

### 6.4 Menu 3 Setup

Navigation within Menu 3 is similar to that described in Menu's 1 and 2. Features designated with an asterisk (\*) are optional. Operation of optional features is dependant upon model and options selected at the time of order. The following setup menus are based on firmware version 2.27 or higher.

			
SETUP or ESCAPE	INCREASE or NEXT	DECREASE or PREVIOUS	ENTER or ACCEPT



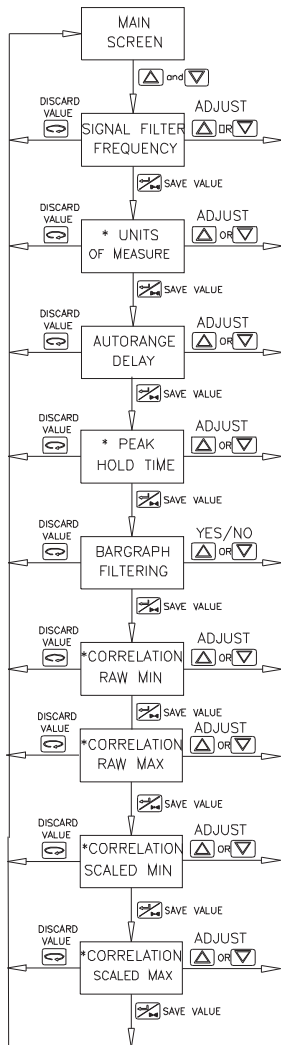

Press the UP and DOWN keys at the same time from the main screen to enter the Menu 3 setup screen. Use the UP/DOWN arrow keys to adjust a setting to the desired value. Press the ENTER key to save the value and proceed to the next screen. Press the SETUP/ESCAPE key to return to the main screen without saving the current parameter's value.



Menu Item	Range	Definition
Signal Filter Frequency	0.033 – 2.0 Hz	This parameter controls the low-pass filtering of the input signal. Setting the frequency lower gives a more stable output reading. Setting the frequency higher gives a more dynamic output reading. Signal filtering is applied to the numeric readout only unless bar graph/4-20mA filtering is ON (see setting below).
* Units of Measure	1111 pA 2222 mg	This parameter sets the displayed and output units of measure to be either pA or mg/m <sup>3</sup> . Conversion to mg/m <sup>3</sup> first requires correlation testing and instrument scaling.
Auto-Range Delay	1 – 30 Sec	This parameter controls how long the bar graph readout must be at either extreme before it automatically switches ranges. If the bar graph is switching ranges too often, the auto-range delay should be increased.
* Peak Hold Time	0 – 60 Sec	This parameter sets the amount of time a rapidly occurring peak reading is displayed. Peak Hold is used for processes that are very dynamic with spiking readings.
* Bar Graph & 4-20mA Output Filtering	Yes/No	This parameter enables or disables filtering of the bar graph and the optional 4-20mA output. The filtering applied is the Signal Filter Frequency parameter listed above. Filtering is enabled by selecting YES and disabled by selecting NO.
* Correlation Values MINIMUM and MAXIMUM (EM 70)	0 – 5000 pA1=0 pA2=5000 pA3=0 pA4=5000	These parameters are used to re-scale the output from pA to mg/m <sup>3</sup> . Raw min/max values (pA1 and pA2) are entered and equivalent Scaled min/max values (pA3 and pA4) are entered. The control unit will convert the Raw values to Scaled values automatically. To remove all scaling, set Raw min=Scaled min and Raw max=Scaled max. Example: 0-5000pA = 0-4000mg/m <sup>3</sup> pA1=0, pA2=5000, mg3=0, mg4=4000

### 6.5 Long Term Averaging

The long term averaging function provides a rolling average of the real-time readings over time.

			
SETUP or ESCAPE	INCREASE or NEXT	DECREASE or PREVIOUS	ENTER or ACCEPT

Press the ENTER key to toggle between the Real-Time display and the Average display.

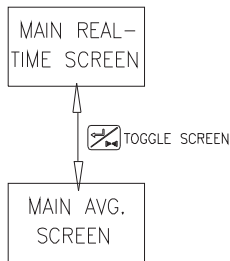

Main Screen	Units Shown	Description
Real-Time Display	pA	Displays the real-time reading. Before display, the real-time reading is processed through a low-pass input signal filter which smoothes the reading. See the low-pass "Signal Filter Frequency" setup in the Menu 3 setup section.
Average Display	ApA	Displays a selectable rolling time average of the real-time reading. The average period (in minutes) is adjustable through the average setup screen. The word "AVG" is quickly shown in place of the readout once every five seconds, indicating that the displayed and output reading is an average.

Averaging setpoints are accessed through averaging setup screen. To enter the averaging setup screen, press the SETUP key while viewing the MAIN AVERAGE screen. Navigation within the setup menu is similar to that described in the previous setup screens.

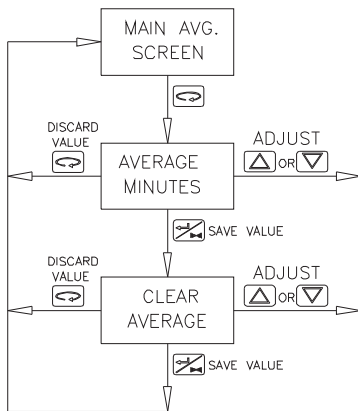

Press the SETUP key from the MAIN AVERAGE screen to enter the AVERAGE setup screen. Use the UP/DOWN arrow keys to adjust settings to the desired values. Press the ENTER key to save a value and proceed to next setup screen. Press the SETUP/ESCAPE key to return to the main average screen without saving the current parameter's value.

Menu Item	Range	Definition
Average Period	0-360 Min	Number of minutes the real-time reading is averaged to compute the average reading.
Clear Average	YES/NO	When YES is selected and the enter key is pressed the averaging is cleared and the average reading is initialized to 0.



## 6.6 4-20mA Analog Output Scaling

Particulate levels may be transmitted to external devices with the 4-20mA analog output. Typical applications include remote monitoring of particulate levels with a PLC, chart recorder or panel meter. The 4-20mA output is transmitted as linear or multi-decade logarithmic output.

Two parameters determine the type of output signal. The “4-20mA Minimum Scale” parameter determines the pA equivalent of the 4mA output. Setting this parameter to “0.0” enables the Linear scale. A value other than “0.0” initiates Logarithmic scale. The “4-20mA Output Span” parameter determines the pA equivalent of the 20 mA output.

The 4-20mA analog output represents the linear or logarithmic equivalent of the “pA” particulate levels. Once the analog output has been transmitted to the PLC or chart recorder, it is recommended to convert the 4-20mA signal back into pA to assist in data interpretation, alarm level determination and historical data comparison. This can be of particular importance for EPA regulatory applications. The following two examples show the formulas used to convert the 4-20mA signal into pA.

### 4-20mA Linear Output

Linear output is selected when the “4-20mA Output Minimum Scale” is set to “0.0” pA. To convert the 4-20mA output signal back to pA, use the following formula:

$$\text{pA} = ((4\text{-}20\text{mA Output Span}) * (\text{mA} - 4)) / 16$$

Example:

Where: **4-20mA Minimum Scale = 0.0** and  
**4-20mA Output Span = 1000pA (from Menu #2)**

4-20mA Output	pA
4	0.0
5	62.5
6	125.0
7	187.5
8	250.0
9	312.5
10	375.0
11	437.5
12	500.0
13	562.5
14	625.0
15	687.5
16	750.0
17	812.5
18	875.0
19	937.5
20	1000.0

## 4-20mA Logarithmic Output

To convert the 4-20mA logarithmic output back to pA, use the following formula:

1. Compute the number of output decades:

$$\text{Number\_Of\_Decades} = \text{Log} [(4\text{-}20\text{mA Output Span}) / (4\text{-}20\text{mA Minimum\_Scale})]$$

2. Scale mA input to proper log(10) argument:

$$Y = \text{Number\_Of\_Decades} * (\text{mA} - 4.00) / 16$$

3. Convert log(10) argument to pA:

$$\text{pA} = 10^{(Y)} * (4\text{-}20\text{mA Minimum\_Scale})$$

**Example #1:** See Menu #2 for details.

Where: **4-20mA Minimum Scale = 0.1pA**

**4-20mA Output Span = 1000pA**

**Number\_Of\_Decades = Log (1000 / 0.1) = 4**

4-20mA Output	Y	pA
4	0	0.1
5	0.25	0.2
6	0.5	0.3
7	0.75	0.6
8	1	1.0
9	1.25	1.8
10	1.5	3.2
11	1.75	5.6
12	2	10.0
13	2.25	17.8
14	2.5	31.6
15	2.75	56.2
16	3	100.0
17	3.25	177.8
18	3.5	316.2
19	3.75	562.3
20	4	1000.0

**Example #2:** See Menu #2 for details.

Where: **4-20mA Output Minimum Scale = 0.5pA**

**4-20mA Output Span = 500pA**

**Number\_Of\_Decades =  $\text{Log}(500 / 0.5) = 3$**

<b>4-20mA Output</b>	<b>Y</b>	<b>pA</b>
4	0.00	0.5
5	0.19	0.8
6	0.38	1.2
7	0.56	1.8
8	0.75	2.8
9	0.94	4.3
10	1.13	6.7
11	1.31	10.3
12	1.50	15.8
13	1.69	24.3
14	1.88	37.5
15	2.06	57.7
16	2.25	88.9
17	2.44	136.9
18	2.63	210.8
19	2.81	324.7
20	3.00	500.0

## 6.7 Interpreting Particulate Readings for Fabric Filter Applications

Particulate flow is very dynamic in nature, thus the output signal is also usually very dynamic. This is more often the case with fabric filter and dust collection exhaust monitoring applications where filter emissions and filter cleaning systems can cause wide ranging variations in the particulate levels. When monitoring downstream of fabric filter, it is often possible for the difference between baseline readings and peak readings following cleaning cycles, to vary by a factor of 10 or even 100. This is the reason for the logarithmic output (linear output is also easily selected using the keypad).

The logarithmic scale provides the ability to simultaneously monitor and resolve the baseline and peak readings. It is not uncommon to have baseline readings of less than 10pA while at the same time peak readings may be over a hundred or more.

Particulate levels listed below are typical for new or well maintained bag or cartridge filter dust collection system. Many factors, other than generic bag wear may contribute to high particulate levels including but not limited to: Improper filter installation, bad tube sheet seals, improper filter media for process conditions, high differential pressure or a lack of a filter cake buildup.

**IMPORTANT**

**PARTICULATE READING GUIDE FOR FABRIC FILTERS**

- The guide below is only an approximate guide for modern, highly-efficient baghouses
- With larger or older baghouses, readings can be significantly higher than the ranges shown below
- Shaker and reverse air baghouses will have higher peak readings as compared to pulse jet
- Readings tend to be higher when new filters are installed and a filter cake has yet to form
- With small cartridge filters, the readings tend to be at the lower end of the ranges
- Readings tend to also be lower with highly-efficient filter media such as Gore-Tex® fabric (Gore-Tex is a registered trademark of W.L. Gore & Associates.)
- 

**Typical Readings and Guide for New Efficient Fabric Filters**

<b>AVERAGE BASELINE READINGS</b>	<b>PEAK READINGS (after cleaning cycle)</b>	<b>FILTER CONDITION</b>
1 – 10 pA	Less than 50pA	No significant emissions
10 – 100 pA	Less than 500pA	Onset of emissions
100 – 1000pA	Greater than 500pA	Significant emissions present

**IMPORTANT**

**ALARM LEVELS FOR EPA COMPLIANT LEAK DETECTION**

- Alarm levels for EPA compliant leak detection such as MACT regulations should initially be set as low as possible until sufficient trend data has been logged and all considerations have been made.
- Do not increase the alarm levels without proper justification.
- Documentation of properly determined alarm levels is recommended as well as locking out alarm set point adjustment except to authorized personnel.
- Consult factory for alarm set point assistance and or FilterWare Visualization and EPA Compliance Software for advanced alarming and alarm record keeping.

### 6.8 Alarm Levels for Fabric Filter Applications

For fabric filter applications it is recommended to set two alarm levels either using the internal alarms and or using the optional 4-20mA output signal that is sent back to a PLC or other recording system. One alarm should be set based on the average base line reading and another alarm should set based on the peak readings following cleaning cycles.

Normally, Alarm #1 is used for detecting sustained increases in the base line reading. For example a baghouse that has new, highly-efficient filters may have an average baseline reading of 10-20pA. It would then be recommend to set the baseline alarm at 30-50pA with an alarm delay time that was long enough so that cleaning cycle peaks did not activate the baseline alarm. Each application can be different (for example much higher readings are possible with larger, older baghouses) and each plant may have different operating demands in terms of how sensitive the alarms should be set. It is, therefore, recommended to initially set the alarm as low as possible and to trend and data log the readings over time before finalizing the settings. Correlations to stack test data can also be incorporated to correlate the output to actual mass concentration to set more quantitative alarms.

Normally, Alarm #2 is set to detect changes in the peak readings caused by the filter cleaning cycles. Recall that as filters just begin to tear or become porous, the momentary puffs of particulate emissions that normally occur just after a cleaning cycle will increase in peak height and duration (peak width). Essentially the cleaning cycle amplifies the existence of small tears. Thus, setting an alarm to detect changes in the peak emissions is often referred to as a Pre-Visible Alarm as it is the best, and most reliable, approach to detecting emissions before become visible. When a sustained increase in the baseline level occurs, particulate emissions will likely be visible and the filters should be changed immediately. Where as, when only the peak emissions have increased, emission will likely not be visible and there likely would be time to schedule changing the filters (i.e. early warning).

Telephone or on-site assistance is available to provide suggestions in setting alarm levels.

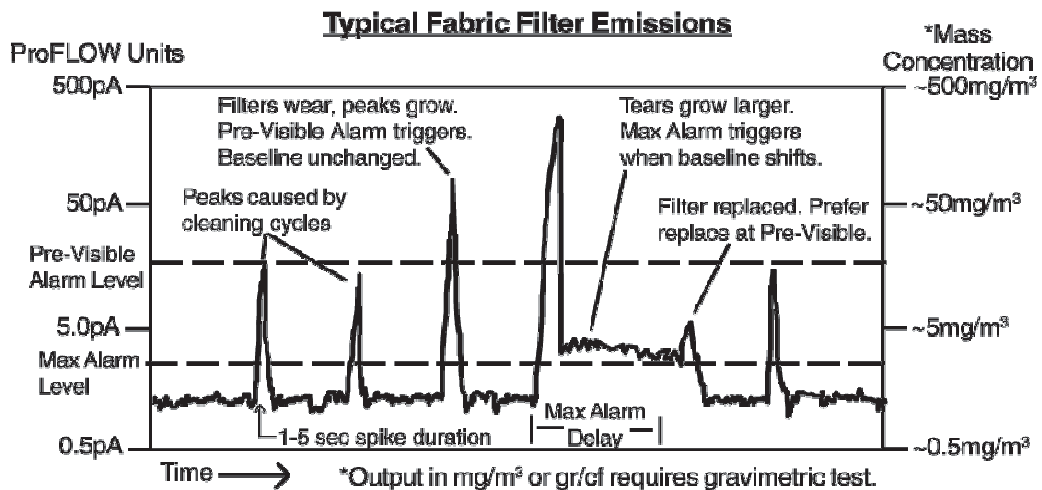

## 7. Manual System Zero Check

The System Zero Check is used at installation to confirm proper installation and for troubleshooting. This check is mostly for control units that are not equipped with the optional self check subsystem.

---

### WARNING



### SAFETY

- Always disconnect power to the control unit before making any wiring changes at either the control unit or sensor as well as when making any mounting changes or replacing any component.
- Do not remove the sensor (even when power is disconnected) from a running process if it will in any way compromise personnel or plant safety.
- All regulatory and plant safety procedures must be followed at all times while performing any equipment check or maintenance.
- For hazardous area sensors, do not disconnect the external earth ground strap.
- Do not perform any procedure if it will in any way compromise hazardous area procedures.



---

### SYSTEM ZERO CHECK

1. Shut the process off, stopping flow completely, including all airflow not just particulate flow. The slightest amount of flowing particles can create a signal. If process flow cannot be stopped, the particulate sensor can be removed from the process and installed in a grounded test pipe to create a shielded, no flow condition.
2. Let the system stabilize for 2-3 minutes.
3. Read the display. It should be below the control units specified minimum detection level. If the system passes this check then it is assured that there are no false signals entering the system.

If the system zero check is not successful, each component of the system should be checked individually, in the following order:

1. Control Unit Zero Check
  2. Coaxial Cable Zero Check
  3. Sensor Zero Check
-

**CONTROL UNIT ZERO CHECK**

1. Disconnect power to the control unit.
2. Open the enclosure cover and unscrew the coaxial cable connector from the control unit. Leave the connector inside the control unit enclosure. Make sure the connector does not slip down into the conduit.
3. Close the control unit enclosure cover.
4. Re-apply power to the control unit and allow the reading to stabilize for 1-2 minutes.
5. Read the display. It should be below the control units specified minimum detection level. If the control unit passes this check, there are no false signals entering the control unit.

**PASS:**

1. Disconnect power from the control unit.
2. Open the enclosure cover and re-attach the coaxial cable connector to the control unit.
3. Close the enclosure cover and proceed to the Coaxial Cable Zero Check.

**FAIL:**

1. If a zero reading cannot be obtained, close the enclosure cover and contact the factory for further assistance.
- 

**COAXIAL CABLE ZERO CHECK**

1. Disconnect power to the control unit.
2. Open the sensor enclosure cover and disconnect the coaxial cable center conductor from the sensor probe end. Do not disconnect the coaxial cable shield. Do not remove the probe from the process. Leave the coaxial cable center conductor ring terminal hanging in free space within the sensor enclosure (do not isolate it with tape) and close the cover.
3. Re-apply power to the control unit and allow the reading to stabilize for 1-2 minutes.
4. Read the display. It should be below the control units specified minimum detection level. If the coaxial cable passes this check then there are no false signals entering the coaxial cable.

**PASS:**

1. Disconnect power to the control unit.
2. Open the sensor enclosure cover and re-attach the coaxial cable center conductor to the sensor probe end.
3. Close the sensor enclosure cover and proceed to the sensor zero check.

**FAIL:**

1. Check cable installation and routing instructions in the Installation section of this manual for proper cable installation. Make any changes necessary.
  2. Contact the factory for further assistance.
-

Once the control unit and coaxial cable zero have been checked, proceed to the Sensor Zero Check. To perform the sensor zero check the process flow must be stopped or a sensor test pipe (available from Factory) or length of metal pipe will be needed (4"-6" diameter pipe or larger). The pipe should be at least 3 in (8 cm) longer than the probe itself and must be grounded. The length of pipe will serve as an electrical shield for the probe while it is out of the process.

---

**SENSOR ZERO CHECK**

1. Do not remove the sensor from a running process if it will in any way compromise personnel, plant safety or hazardous area safety procedures.
2. Disconnect power to the control unit.
3. Remove the sensor from the process and insert it into the grounded metal test pipe. For hazardous area sensors do not disconnect the external sensor earth ground strap.
4. Re-apply power to the control unit and allow the reading to stabilize for 1-2 minutes.
5. Read the display. It should be below the control units specified minimum detection level. If the sensor passes this check there are no false signals from the sensor.

**PASS:**

1. Disconnect power to the control unit.
2. Remove the sensor from the grounded test pipe and re-insert into the process. For hazardous area sensors do not disconnect the external sensor ground strap.

**FAIL:**

1. Contact the factory for further assistance.

---

When performing a zero check, keep in mind that it may be acceptable to consider a small false signal negligible. For example if the baseline readings are 100pA and a system zero offset of 1pA was found, this is only a 1% affect on the normal readings. If using the device for basic flow/no flow detection or basic emissions detection, this would not be significant.



## 8. Automatic Self Checks

An optional self check subsystem is available to automatically verify calibration and proper operation of the electronics, sensor and cable. Self checks can be performed while the system is online and monitoring particulate. No external test equipment or operator intervention is required to activate or complete the self check routines. Any errors detected by the self checks are reported through the display, 4-20mA, relay and Modbus® outputs. The following automatic self checks are performed:

- Control Unit Hardware Check
- Control Unit Calibration (Zero and Span)
- Sensor Cable Check
- Particulate Sensor/Probe Check

The control unit zero and span self checks that are performed meet all requirements of the EPA MACT Quality Assurance specifications. Self checks are automatically run every hour. A manual Self Check may be activated anytime through the control unit keypad.

### 8.1 Control Unit Hardware Check

The Control Unit Hardware Check is an automatic check of all major electrical components in the control unit. This check is automatically performed each time power is applied to the control unit.

Check	Description
Watchdog Timer	Monitors all program tasks running in the microprocessor and automatically resets the processor in the event of lock-up.
SRAM	Checks the integrity of the SRAM memory.
Non-Volatile Memory	Checks the integrity of the Non-Volatile memory. The results of this check produce a checksum value which is analyzed each time a non-volatile memory write occurs.
Option Board	Checks for proper installation of Power Supply, RS-485 and Self Check option boards.
Analog Converter Calibration	Checks calibration of the 22 bit high resolution analog converter.

## 8.2 Control Unit Zero Check

The Zero Check will verify instrument zero calibration. The internal self check subsystem will automatically perform the following procedure:

1. Electronic disconnect of the particulate sensor cable
2. Allow the reading to stabilize
3. Measure the reading and compare to the allowable zero tolerance
4. Electronic re-connect of the particulate sensor cable and resume normal operation.

There are four independent methods to activate the zero check:

Method	Description
Power-Up	A zero check is automatically performed each time power is applied to the control unit
Keypad	The operator may activate a zero check manually through the control unit keypad. Reference Menu #2 setup tree for complete details.
Automatic	<p>The control unit may be configured to automatically perform a zero check on a period basis. A re-settable delay timer controls the time period between self checks. The delay timer is set to 1 hour by default. The delay timer is reset each time self checks are performed regardless of the activation method.</p> <p>Automatic self checks may be activated at preset hourly, daily and monthly dates/times when connected to a computer running the FilterWare Visualization application.</p>
Remote	The operator may activate a zero check manually when connected to a remote computer running the FilterWare Visualization application. Alternately, self checks may be independently activated from any remote PC or PLC with Modbus® communication capability.

### 8.3 Control Unit Span Check

The Span Check will verify the instrument span calibration. The internal self check subsystem will automatically perform the following procedure:

1. Electronic disconnect of the particulate sensor cable
2. Electronic input of a calibrated pA reference signal
3. Allow the reading to stabilize
4. Measure the reading and compare to the allowable span tolerance
5. Electronic disconnect of the reference signal
6. Electronic re-connect of the particulate sensor cable and resume normal operation.

There are four independent methods to activate the span check:

Method	Description
Power-Up	A span check is automatically performed each time power is applied to the control unit
Keypad	The operator may activate a span check manually through the control unit keypad. Reference Menu #2 setup tree for complete details.
Automatic	The control unit may be configured to automatically perform a span check on a period basis. A re-settable delay timer controls the time period between self checks. The delay timer is set to 1 hour by default. The delay timer is reset each time self checks are performed regardless of the activation method.  Automatic self checks may be activated at preset hourly, daily and monthly dates/times when connected to a computer running the FilterWare Visualization application.
Remote	The operator may activate a span check manually when connected to a remote computer running the FilterWare Visualization application. Alternately, self checks may be independently activated from any remote PC or PLC with Modbus® communication capability.

### 8.4 Sensor Cable Check

Integrity of the sensor cable is checked using advanced digital signal processing algorithms. The cable check operates continuously and does not interfere with normal monitoring of the process particulate signal. The sensor cable check is disabled while zero or span checks are being performed.

For proper operation of the sensor cable check a process running signal must be provided to the control unit. Reference section 8.6 for full details.

### 8.5 Particulate Sensor Check

Operation of the particulate sensor/probe is checked using advanced digital signal processing algorithms. The particulate sensor check operates continuously and does not interfere with normal monitoring of the process particulate signal. The particulate sensor check is disabled while zero or span checks are being performed.

## 8.6 Process Running Signal

A process running signal indicates to the control unit whether the main process fan is ON or OFF. Connection of a process running signal adds the following capabilities to the automatic self check subsystem:

1. Sensor cable check – reference section 8.4 for further details.
2. Automatic system zero – verifies zero of the total system electronics, cable and sensor while fully installed in the process.

For proper operation the following conditions must be met:

1. A process running signal must be connected to the control unit process run relay input channel. This signal must be provided from an isolated, non-powered relay contact that closes when the main process fan is on, and opens when the main process fan is off. A motor starter auxiliary contact and/or separate control relay are typically used to provide this signal to the control unit. Refer to the installation drawings for details on making connections to the relay input channel.
2. The process run relay input channel must be enabled for use. Reference menu #2 setup tree for complete details.

## 8.7 Monitoring Self Check Status

There are four independent methods to monitor the status of the self check subsystem.

### LCD Display

The control unit's LCD display will indicate the current status of the self check subsystem as listed below:

PV Units Display	Indication
'pA' or 'mg'	No self checks currently running. The most recent self checks were successful, no failures
'SC1'	Zero check in process
'SC2'	Span check in process
'ER1'	Zero error
'ER2'	Span error
'ER3'	Sensor error
'ER4'	Cable error
'ER5'	SRAM error
'ER6'	Non-Volatile memory error
'ER7'	Option board error
'ER8'	Analog converter error
'ER9'	System zero error

**Alarm Relay**

An alarm output relay can be activated if any self checks are unsuccessful. The alarm relay will remain activated until a subsequent self check is performed successfully, or power to the control unit is disconnected. Alarm relay #1 will be activated in the event of a self check failure by default. Alarm output relays may be configured to operate in normal or fail-safe modes.

**4-20mA Output**

The 4-20mA output will be driven to non-standard levels to indicate self check status as listed below:

<b>mA Output</b>	<b>Indication</b>
3.8mA	Zero or span check in process, sensor is disconnected
3.6mA	A self check error has occurred

**Serial or Ethernet Communication Network**

All information regarding status, control and setup of the self check subsystem is accessible as register data through the control unit's communication network. See the Modbus® register map at the end of this document for a complete detailed listing of registers data available.

**8.8 Particulate Alarming During Self Checks**

All particulate alarms are put in a suspend mode while a self check is being performed. When a self check is completed, all particulate alarms will resume normal operation.

**8.9 Self check Recording**

EPA MACT regulations require that plants maintain a record of all self checks performed. To reduce the number of plant personnel required to generate these records, the control unit provides two methods suitable for automated record generation.

**4-20mA Output**

The 4-20mA output will be driven to specific, non-standard levels to indicate that self checks are being performed and if any self check has failed. A PLC may be easily configured to monitor for these specific, non-standard, mA levels and transmit status information to a central plant information network for record storage.

**Serial or Ethernet Communication Network**

The overall status of each self check, as well as the results of the most recent self checks performed, are accessible through the Modbus® network port. This information may be monitored and logged with a remote PC running SCADA application software. Optional FilterWare Visualization and Reporting software is available to monitor all of the control units self check information and automatically generate MACT compliant self check reports.

## 9. Troubleshooting

The following is primarily used when troubleshooting a system without the optional automatic self checks. When troubleshooting, consider each component of the system: The control unit, the sensor coax cable and the sensor assembly.

### False High Signals (False Alarms)

1. When an apparent false high signal is present, first check the process to be sure the particulate level has not increased. Keep in mind that the system can detect very low levels. In filtration applications the system can detect invisible particulate levels and very small emissions.
2. Check the sensor cover and conduit seal to be sure they were not left open allowing rain to enter the housing. Check the coaxial cable connectors using a digital voltmeter and check for shorts. If nothing can be found, conduct a manual system zero check.

### No Reading or Alarm (When Believed Necessary)

1. Increase the particulate level or introduce particulate into the air stream and monitor for a response. If the system responds properly re-evaluate the selected alarm points and the process conditions.
2. If there is no response, check for electrical continuity from the sensor to the control unit end of the coax cable.
3. Contact the factory for a Field Test Unit that can generate a signal to check response and calibration.

## 10. Routine Maintenance

### WARNING



### EQUIPMENT MAINTENANCE

- Only appropriately licensed professionals should perform maintenance on this product.
- For operator safety and to prevent ignition of flammable or combustible atmospheres always disconnect power before servicing.

**Particulate Sensor:** There is no electronic calibration or zero adjustment for the sensor. The sensor does not normally need any cleaning and for optimal performance, routine cleaning of the sensor is not recommended.

**Control Unit:** The viewing window, keypad and enclosure may be cleaned with soap and water as needed. Use a soft cloth to prevent scratching the window. Do not use an abrasive pad or any chemicals that will attack plastic or Lexan.

## 11. Spare Parts

Item	Details	Mfr Part No.
Line Fuse, 115/230VAC	0.032A 250V Slo-Blo type 'T'	LittleFuse 218.032
	0.050A 250V Slo-Blo type 'T' when Self Check Option is installed	LittleFuse 218.050
Line Fuse, 24VDC	0.250A 250V Slo-Blo type 'T'	218.250
Control Unit	Control Unit Family	Refer to Product Label
Particulate Sensor	Variable Lengths & Connections	Refer to Product Label
Particulate Sensor Cable	Coax, SMA x Ring Lugs	CCA-Feet

## **12. Appendix**

**Modbus®/RTU RS-485 Networking Protocol**

**Ethernet/IP® Networking**

**Installation & Hazardous Area Control Drawings**



## 12.1 Modbus®/RTU RS-485 Networking Protocol

The RS-485 networking feature allows up to 32 control units to be connected to a multi-drop communications network. When connected to the network, any device on the network may be monitored and controlled by a remote device such as a PLC or Computer using Modbus®/RTU protocol.

### Network Hardware Description

RS-485 is a standard industrial network used for serial communications between multiple devices from a single connection. Electrical communication signals are transmitted differentially providing immunity to electrical noise and power supply variances. Signals are transmitted between devices over a single twisted pair wire with shield. Communications are half-duplex (cannot transmit and receive at the same time). Serial baud rate is fixed at 19,200 bps. The serial frame is fixed at 8 data bits, 1 stop bit and no parity. Communications are supported over a maximum network length of 4000 feet. When connecting more than two devices on the network, all devices should be wired 'in-line' and not in a 'star' configuration.

A terminating resistor must be present at each end of the RS-485 network to eliminate transmission reflections on the serial line. Some control units contain a two-position jumper to allow the device to be either terminated (T) or un-terminated (U). The terminating resistor connected in the (T) position is 120Ohms. All other devices on the network that are not at a network end must be set to un-terminated (U). For control units that do not contain a terminating jumper, a 120ohm ½ watt resistor may be placed across the RS-485 +/- output terminals.

### PLC Connection

Connection to plant PLC's is dependant upon the communications ports available on the specific PLC being used. Ensure that the communications port connected to is not limited to a PLC manufacturer's proprietary network protocol such as Allen-Bradley Data-Highway or Remote I/O. Modicon's Modbus® "Plus" protocol is also not supported. This is a Modbus® RTU protocol.

Some configuration may be required in the PLC to set the communications port to Modbus®/RTU.

### RS-485 Communications Ports

A network connection may be directly wired to any communication ports that support half-duplex RS-485 and Modbus®/RTU protocols. Refer to the PLC manufacturer's literature for specific details on connections to the PLC communications port.

Network connections to RS-232/RS-232C or RS-422 ports are supported with the addition of a converter module. As with the RS-485 port, the Modbus®/RTU protocol must be supported for proper operation. Converter modules are available from the factory. The converter module modifies the voltage levels and wiring connections to allow different RS connections to work together. Converter modules generally require their own power source, which must be provided in the PLC cabinet.

When using an RS-485 to RS-232 converter the converter must be setup so it will transmit when the TD line is asserted.

## Personal Computer Connection

Connection to a personal computer is made to the RS-232 COM port with the addition of a converter module. Converter modules are available from the factory. The converter module modifies the voltage levels and wiring connections to allow different RS connections to work together. Converter modules generally require their own power source, which may be supplied with a wall-mount transformer power supply.

## Network Protocol Description – Modbus®/RTU

The communication protocol used to transmit data between network nodes is Modbus®/RTU developed by Modicon. Devices communicate using a master-slave technique, in which only one device (the master) can initiate transactions (queries). The other devices (slaves) respond by supplying the requested data to the master, or by taking the action requested in the query.

When using our PC software packages the Modbus® protocol is coded into the software so that configuration and operation of the network devices and software is simple. The user has no need to know the specifics of the Modbus® protocol or the types of messages sent and received. All of the low-level communications functions are taken care of and are transparent to the system user. The PC running our software is configured as the network master and all other devices on the network are configured as slaves.

## Modbus® Message Description

The Modbus® protocol establishes the format for the master's query by placing into it the device address, a function code defining the requested action, any data to be sent, and an error-checking field. The slave's response message is also constructed using Modbus® protocol. It contains fields confirming the action taken, any data to be returned, and an error-checking field. If an error occurred in receipt of the message, or if the slave is unable to perform the requested action, the slave will construct an error message and send it as its response.

Three data types are supported:

- Discrete (1-bit)
- Integers (16-bit)
- IEEE Floating point (32-bit)

## Modbus® Protocol Function Codes

Code	Function	Description
01	Read Coil Status	Reads digital outputs or 1 bit data registers
02	Read Input Status	Reads digital inputs or 1 bit data registers
03	Read Holding Register	Reads analog outputs or 16 bit data registers
04	Read Input Register	Reads analog inputs or 16 bit data registers
05	Force Single Coil	Writes digital outputs or 1 bit data registers
06	Preset Single Register	Writes analog output or 16 bit data register
07	Read Exception Status	Reads status information
15	Force Multiple Coils	Writes digital outputs or 1 bit data registers
16	Preset Multiple Registers	Writes analog outputs or 16 bit data registers
17	Report Slave ID	Reads device type information

<b>Modbus®/RTU Registers</b>		
<b>Register</b>	<b>Description</b>	<b>Data</b>
<b>Address</b>	<b>0x Reference: Discrete output coils</b>	<b>Type</b>
00001	Alarm relay 1 (1=ON, 0=OFF)	Bit
00002	Alarm relay 2 (1=ON, 0=OFF)	Bit
03073	Alarm status - alarm 1 (1=ON, 0=OFF)	Bit
03074	Alarm status - alarm 2 (1=ON, 0=OFF)	Bit
03247	Zero Check Running Status (1=Running, 0=Not Running)	Bit
03248	Span Check Running Status (1=Running, 0=Not Running)	Bit
03249	Full System Zero Check Running Status (1=Running, 0=Not Running)	Bit
03251	Zero Check Remote Activation (Set to 1 to Activate)	Bit
03252	Span Check Remote Activation (Set to 1 to Activate)	Bit
03254	Probe & Cable Check Status (1=Error, 0=OK)	Bit
03255	Zero Check Status (1=Error, 0=OK)	Bit
03256	Span Check Status (1=Error, 0=OK)	Bit
03257	Full System Zero Check Status (1=Error, 0=OK)	Bit
<b>Description</b>		
<b>4x Reference: Holding registers</b>		
40609	Process Variable 1 - particulate (pA)	Float
40611	Process Variable 2 - averaged particulate (pA)	Float
42309	Correlation Scaling Raw Minimum (pA)	Integer
40705	Correlation Scaling Raw Maximum (pA)	Integer
40641	Correlation Scaling Scaled Minimum (mg/m <sup>3</sup> or gr/ft <sup>3</sup> )	Integer
40647	Correlation Scaling Scaled Maximum (mg/m <sup>3</sup> or gr/ft <sup>3</sup> )	Integer
40721	Process Variable Units of Measure (0=pA, 1=mg/m <sup>3</sup> , 2=gr/ft <sup>3</sup> )	Integer
40737	Alarm 1 Level - (pA)	Float
40739	Alarm 2 Level - (pA)	Float
40769	Alarm 1 delay - (sec)	Integer
40770	Alarm 2 delay - (sec)	Integer
43363	Zero Check Delay Between Checks (Hours)	Float
43365	Span Check Delay Between Checks (Hours)	Float
43367	Full System Zero Check Delay Between Checks (Hours)	Float
43381	Probe & Cable Check Relay to Activate (0=None, 1=Relay 1, 2=Relay 2)	Integer
43382	Zero Check Relay to Activate (0=None, 1=Relay 1, 2=Relay 2)	Integer
43383	Span Check Relay to Activate (0=None, 1=Relay 1, 2=Relay 2)	Integer
43384	Full System Zero Check Relay to Activate (0=None, 1=Relay 1, 2=Relay 2)	Integer
43399	Zero Check Allowable Tolerance (pA)	Float
43404	Span Check Allowable Tolerance (pA)	Float
43409	Full System Zero Check Allowable Tolerance (pA)	Float
43401	Zero Check Settling Time (milliseconds)	Integer
43406	Span Check Settling Time (milliseconds)	Integer
42402	Result Measured from Last Zero Check (pA)	Float
42407	Result Measured from Last Span Check (pA)	Float
42412	Result Measured from Last Full System Zero Check (pA)	Float

## 12.2 Ethernet/IP® Networking

The Ethernet/IP® networking feature allows communication between control units and other devices on an Ethernet/IP® network. Ethernet/IP® is a common networking protocol supported by Allen-Bradley equipment and other third party vendors.

### Network Hardware Description

Ethernet is one of the most common networking topologies in use today. Devices on the Ethernet network are connected to a central Ethernet switch which links devices together and filters network traffic. Devices must be connected directly to a switch using a standard Category 5e Ethernet cable, or directly to another Ethernet device using a crossover Category 5e Ethernet cable. The maximum length supported for a single Ethernet connection is 100 meters, additional lengths require installation of switches/repeaters or alternate networking hardware such as fiber optics. Ethernet networks typically run at a speed of 100Mbps. Both 10Mbps and 100Mbps data rates are supported by the control unit with an auto-sensing Ethernet PHY interface.

The control unit is available with a Modbus®/RTU RS485 communication port located directly within the control unit enclosure. The particulate monitor's Ethernet/IP® interface is typically supplied as an external converter housed in a separate enclosure due to the limited space within the standard control unit enclosure. The Ethernet/IP® converter translates between Ethernet/IP® network messages and Modbus®/RTU control unit messages. With this functionality the control unit appears as an ordinary Ethernet/IP® device on the Ethernet network.

### Network Protocol Description

Ethernet/IP® is an open networking protocol governed by the Open DeviceNet Vendor Association (ODVA) and was originally developed by Allen-Bradley. It is built upon a producer/consumer connection structure where data is grouped into assemblies for transmission over the network. Connections between devices requiring communications on an Ethernet/IP® network are created as either an I/O or Explicit messaging type. Explicit connections are supported only for factory configuration data, no user data is available over an explicit connection. A maximum of 1 Ethernet/IP® I/O connection and 2 Ethernet/IP® TCP connections are supported.

The TCP stack currently being used does not properly support TCP Keepalive functionality. Therefore, when an Ethernet/IP® UDP I/O connection is established, if there is no Ethernet/IP activity on the parent TCP connection, the UDP and TCP connections will time-out after 30 seconds. This can be easily avoided by adding a periodic Get\_Attribute\_Single request (every 15-20 seconds is fine) from the I/O client. This request will keep the TCP connection alive and prevent time-out from occurring.

For complete details on the Ethernet/IP protocol visit the ODVA website at [www.odva.org](http://www.odva.org).

### Explicit Message Connections

Changes to the Ethernet/IP® module's internal configuration are accomplished with explicit messages. Contact the factory for further information on internal configuration changes above and beyond IP address and Subnet mask.

Explicit messages may be issued by various software packages, most typically RSNetworx® for Ethernet/IP® from Rockwell Software or EIPScan® from Pyramid Solutions. From within RSNetworx® for Ethernet/IP® explicit messages may be issued with the Class Instance Editor as shown below:

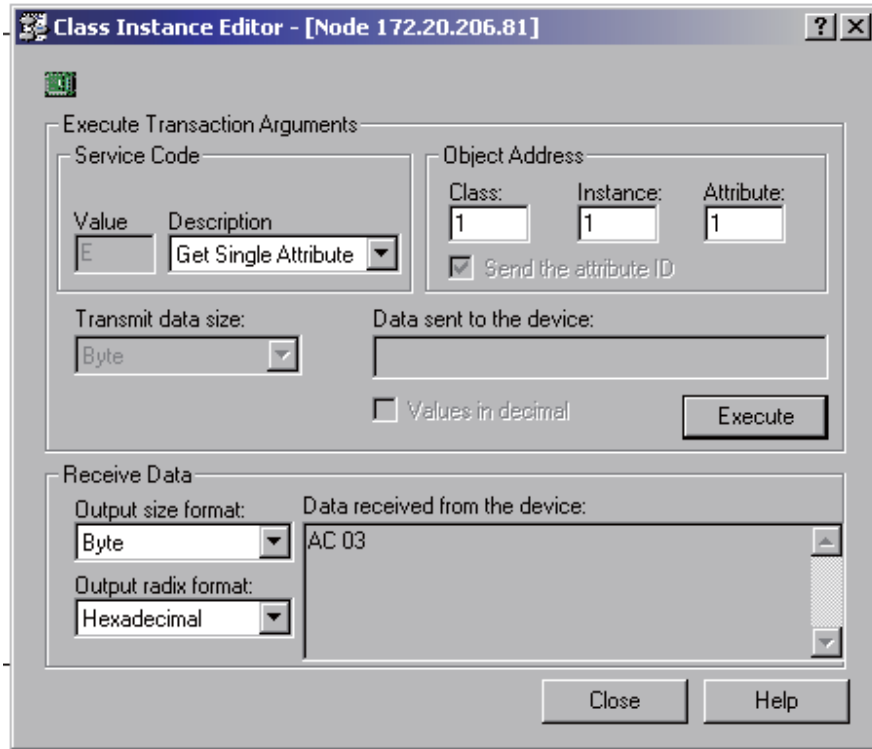

**Network Addressing and BOOTP Behavior**

Communication over an Ethernet network typically requires a device to be setup with two addressing parameters, a MAC address and an IP address. The MAC address of the Ethernet/IP® module is fixed and is listed on the enclosure.

The IP address is set to a factory default value of 192.168.0.254 with subnet mask 255.255.255.0 when shipped. To change the IP address a BOOTP server must be present on the Ethernet network. The following procedure is used to change the IP address:

1. The Ethernet/IP® module must be unlocked to allow changes to its internal configuration. By default the module is locked at power-up. To toggle the lock state the following explicit message must be sent to the module:

Service	Class	Instance	Attribute	Data
0x45	0x67	0x89	0xAB	0xCD

2. BOOTP operation within the module must be ENABLED. By default BOOTP operation is disabled. After the IP address has been set BOOTP operation must be set back to disabled. To ENABLE BOOTP operation the following explicit message must be sent to the module:

Service	Class	Instance	Attribute	Data
0x10	0x64	0x01	0x6E	0x01

3. Launch a BOOTP server on the network and configure it with the MAC address of the module and the desired new IP address and Subnet mask.
4. Cycle power to the module. Once power is re-applied the module will broadcast a BOOTP request for an IP address. The BOOTP server should respond by assigning the desired IP address to the module.
5. Unlock the module again to allow changes to the configuration. To toggle the lock state the following explicit message must be sent to the module:

Service	Class	Instance	Attribute	Data
0x45	0x67	0x89	0xAB	0xCD

6. BOOTP operation within the module must be DISABLED. To DISABLE BOOTP operation the following explicit message must be sent to the module:

Service	Class	Instance	Attribute	Data
0x10	0x64	0x01	0x6E	0x00

7. Cycle power to the module. Once power is re-applied the module will come online with the new IP address and Subnet mask. BOOTP operation should be disabled at this point so no BOOTP requests will be issued by the module.
8. A network ping should be used to verify that the IP address and Subnet mask have been set correctly.

The control unit must always be configured with Modbus®/RTU RS-485 network address set to 1.

#### Input (T->O) Assembly Object (Class 0x04, Instance 0x65)

The following is a mapping of I/O values for the standard Ethernet/IP® assembly object instance 0x65. These are values that are sent from the Ethernet/IP® server (control unit) to the Ethernet/IP client (typically a PLC). The input assembly size is 13 (16 bit words).

#### Data Types

Bool – 1 bit Boolean discrete data

Usint – 16 bit unsigned integer analog data

Sint – 16 bit signed analog data

Float – 32 bit signed floating point analog data

Floating point values are represented in IEEE format (32-bit) where the 1<sup>st</sup> register is the LOW word and the 2<sup>nd</sup> register is the HIGH word.

#### Input (T->O) Assembly Object (Class 0x04, Instance 0x65) Size 13 (16 bit words)

16-Bit Word	Modbus®	Range	Range	Units	Data Type	Description
Address	Address	Min	Max			
0	-	0	65535		Usint	Network status (0=ok, >0=error)
1	-	0	65535		Usint	Alarm status 1-16 (1 = alarm, 0 = ok)
1:0	03073	0	1		Bool	Alarm status – Max alarm #1 (1=ON, 0=OFF)
1:1	03074	0	1		Bool	Alarm status – Pre-Visible alarm #2 (1=ON, 0=OFF)
2	-	0	65535		Usint	Self check status information
2:0	03247	0	1		Bool	Zero check status (1=RUNNING, 0=NOT RUNNING)
2:1	03248	0	1		Bool	Span check status (1=RUNNING, 0=NOT RUNNING)
2:2	03249	0	1		Bool	Full system zero check status (1=RUNNING, 0=NOT RUNNING)
2:3	-	0	1		Bool	Not Used
2:4	03251	0	1		Bool	Zero check remote activate (1=ACTIVATED, 0=NOT ACTIVATED)
2:5	03252	0	1		Bool	Span check remote activate (1=ACTIVATED, 0=NOT ACTIVATED)
2:6	-	0	1		Bool	Not Used
2:7	03254	0	1		Bool	Probe and cable check status (1=ERROR, 0=OK)
2:8	03255	0	1		Bool	Zero check status (1=ERROR, 0=OK)
2:9	03256	0	1		Bool	Span check status (1=ERROR, 0=OK)
2:10	03257	0	1		Bool	Full system zero check status (1=ERROR, 0=OK)

2:11 Thru 2:15	-	0	1		Bool	Not Used
3	40609	0	5000	pA	Float	Particulate process variable LO word
4	40610					Particulate process variable HI word
5	40611	0	5000	pA	Float	Averaged particulate process variable LO word
6	40612					Averaged particulate process variable HI word
7	40737	0	5000	pA	Float	Alarm level – Max alarm #1 LO word
8	40738					Alarm level – Max alarm #1 HI word
9	40739	0	5000	pA	Float	Alarm level – Pre-visible alarm #2 LO word
10	40740					Alarm level – Pre-visible alarm #2 HI word
11	40769	0	600		Usint	Alarm delay – Max alarm #1
12	40770	0	600		Usint	Alarm delay – Pre-visible alarm #2

**Output (O->T) Assembly Object (Class 0x04, Instance 0x66)**

The following is a mapping of I/O values for the standard Ethernet/IP® assembly object instance 0x66. These are values that are sent from the Ethernet/IP® client (typically a PLC) to the Ethernet/IP® server (control unit). The first word in the map contains the run/idle bit (bit 0). The run/idle bit controls write access to the control unit. When the run/idle bit is set to 0 the control unit is set to idle mode. In idle mode, the Ethernet/IP® server will allow read only access to the control unit. When the run/idle bit is set to 1 the control unit is set to run mode. In run mode, the Ethernet/IP® server will allow both read and write access to the control unit. The run/idle control is defined for communications purposes only and has no affect on any other normal control/sensing/alarming operation of the control unit. The output assembly size is 7 (16 bit words).

**Data Types**

Bool – 1 bit Boolean discrete data

Usint – 16 bit unsigned integer analog data

Sint – 16 bit signed analog data

Float – 32 bit signed floating point analog data

Floating point values are represented in IEEE format (32-bit) where the 1<sup>st</sup> register is the LOW word and the 2<sup>nd</sup> register is the HIGH word.

**Output (O->T) Assembly Object (Class 0x04, Instance 0x66) Size 7 (16 bit words)**

16-Bit Word	Modbus®	Range	Range	Units	Data Type	Description
Address	Address	Min	Max			
0	-	0	1		Usint	Run/Idle mode setting (0=idle/read only, 1=run/read write)
1	40737	0	5000	pA	Float	Alarm level – Max alarm #1 LO word
2	40738					Alarm level – Max alarm #1 HI word
3	40739	0	5000	pA	Float	Alarm level – Pre-visible alarm #2 LO word
4	40740					Alarm level – Pre-visible alarm #2 HI word
5	40769	0	600	Sec	Usint	Alarm Delay HI Particulate
6	40770	0	600	Sec	Usint	Alarm Delay HI Delta P

**Configuration Assembly Object (Class 0x04, Instance 0x80)**

The configuration assembly object is not implemented. However, some Ethernet/IP® clients require one. If this is the case, use Instance ID 0x80 with a data length of 0.



## **Notes:**

IMPORTANT INSTALLATION INFORMATION

- HAZARDOUS AREA LOCATIONS: VERIFY REQUIRED CLASS AND DIVISION AGAINST SPECIFICATION LISTED ON THE PROCESS DEVICE TAG.
- DO NOT INSTALL ANY EQUIPMENT THAT IS NOT TAGGED SUITABLE FOR THE AREA CLASSIFICATION.
- BEFORE INSTALLATION VERIFY THE DEVICE IS TAGGED SUITABLE FOR THE REQUIRED AMBIENT TEMPERATURE, PROCESS TEMPERATURE, PROCESS PRESSURE, AND WETTED MATERIALS.
- THIS DEVICE IS NOT DESIGNED FOR USE AS A FUNCTIONAL SAFETY DEVICE. THE DEVICE MUST NOT BE USED AS PART OF OR AS AN INPUT TO A SAFETY SYSTEM.
- ADHERE TO NEC, GEC, NEMA, NFPA, OSHA INSTALLATION AND MAINTENANCE GUIDELINES AND ALL APPLICABLE LOCAL CODES.
- INSTALLATION AND SERVICE MUST BE PERFORMED BY QUALIFIED PERSONNEL WHILE POWER IS DISCONNECTED AND THE PROCESS IS OFF.

VI.5

WARNING: SUBSTITUTION OF COMPONENTS MAY IMPAIR INTRINSIC SAFETY

CONTROL UNIT MOUNTING

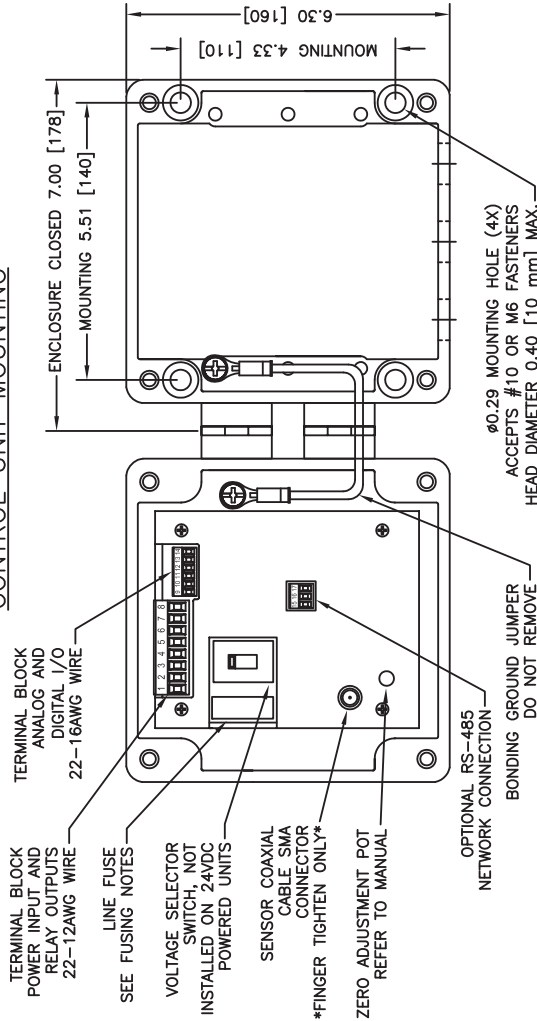

**HAZARDOUS AREA INSTALLATIONS:**

- HAZARDOUS AREA CONTROL DRAWING 225-1005 MUST BE FOLLOWED FOR PROPER INSTALLATION.
- THE CONTROL UNIT MUST ONLY BE LOCATED IN ORDINARY LOCATIONS (NON-HAZARDOUS SAFE AREAS).
- DO NOT LOCATE THE CONTROL UNIT IN A HAZARDOUS AREA UNLESS IT IS INSIDE AN APPROPRIATELY RATED EXPLOSION-PROOF OR PURGED ENCLOSURE AND SUPPLIED AS PART OF AN APPROVED HAZARDOUS AREA SYSTEM WITH APPROVED CONTROL UNIT AND APPROVED SENSOR ASSEMBLY.

**SAFETY:**

- DISCONNECT ALL POWER TO THE CONTROL UNIT BEFORE OPENING THE ENCLOSURE.

**GROUNDING:**

- PROTECTIVE EARTH GROUND WIRE MUST CONNECT TO TERMINAL #1 OF THE MAIN TERMINAL BLOCK. DO NOT REMOVE THE GROUND JUMPER FROM THE ENCLOSURE COVER TO THE ENCLOSURE BASE.
- GROUND JUMPER FROM TERMINAL #1 TO TERMINAL #2 MUST BE INSTALLED FOR PROPER OPERATION WHEN USED WITH PS10 PROBES IN ORDINARY LOCATIONS ONLY.

**ELECTRICAL (ADHERE TO THE NEC AND ALL LOCAL CODES FOR SAFETY)**

- PROPER EARTH GROUND CONNECTIONS MUST BE MADE TO THE SPECIFIED TERMINALS.
- ALL WIRING MUST BE ENCLOSED IN GROUNDED, METAL CONDUIT. ALL POWER WIRING MUST BE 60V MINIMUM.
- USE SEPARATE CONDUIT FOR POWER, CONTROL I/O, ANALOG I/O, COMMUNICATIONS WIRING AND ADHERE TO PROPER SPACING AND ROUTING.
- ANALOG I/O AND COMMUNICATIONS WIRING MUST CROSS POWER AND CONTROL I/O WIRING AT RIGHT ANGLES.
- ROUTE WIRING AND SENSORS AWAY FROM SOURCES OF INDUCTIVE ENERGY AND INSTALL SURGE SUPPRESSION WHERE APPROPRIATE.
- REFER TO IEEE STANDARD 518-1982 AND 1100-1992 FOR FURTHER GUIDELINES.

**FUSING:**

- LINE FUSE: REPLACE WITH T<sup>1</sup> 250V, LITTLEFUSE MODEL 218 OR EQUIVALENT.
- FUSE RATING FOR AC 115VAC, 230VAC POWERED UNITS: 32mA (50mA FOR UNITS WITH SELF CHECK OPTION).
- FUSE RATING FOR DC 24VDC POWERED UNITS: 250mA

**MOUNTING (ADHERE TO THE NEC AND ALL LOCAL CODES FOR SAFETY)**

- MOUNT THE CONTROL UNIT WITHIN SIGHT OF AN APPROPRIATE ELECTRICAL POWER DISCONNECT.
- MOUNT THE CONTROL UNIT SO THE OPERATOR INTERFACE IS AT EYE LEVEL. MOUNTING SHOULD SUPPORT FIVE TIMES THE CONTROL UNIT WEIGHT.
- DO NOT MOUNT THE CONTROL UNIT IN AN AREA OF HIGH VIBRATION OR OUTSIDE THE SPECIFIED TEMPERATURE RANGE.
- ROUTE ALL CONDUIT FROM THE BOTTOM AND ENSURE ALL FITTINGS AND COVERS ARE PROPERLY SEALED.

**PARTICULATE SENSOR COAXIAL CABLE**

- DO NOT SUBSTITUTE AND DO NOT ROUTE WITH ANY OTHER CABLE, EXCEPT OTHER PARTICULATE SENSOR COAXIAL CABLES.
- MAINTAIN SEPARATION OF 18 INCHES (0.5 METER) FROM OTHER CABLING AND INDUCTIVE ENERGY SOURCES. CROSS CONDUCTORS AT RIGHT ANGLES.
- ALL CABLES MUST BE ENCLOSED IN GROUNDED, METAL CONDUIT.
- INSTALL A SERVICE LOOP OF SHIELDED FLEX CONDUIT AT THE SENSOR-END THAT IS 1 TO 2 TIMES THE SENSOR PROBE LENGTH.

WIRE ROUTING

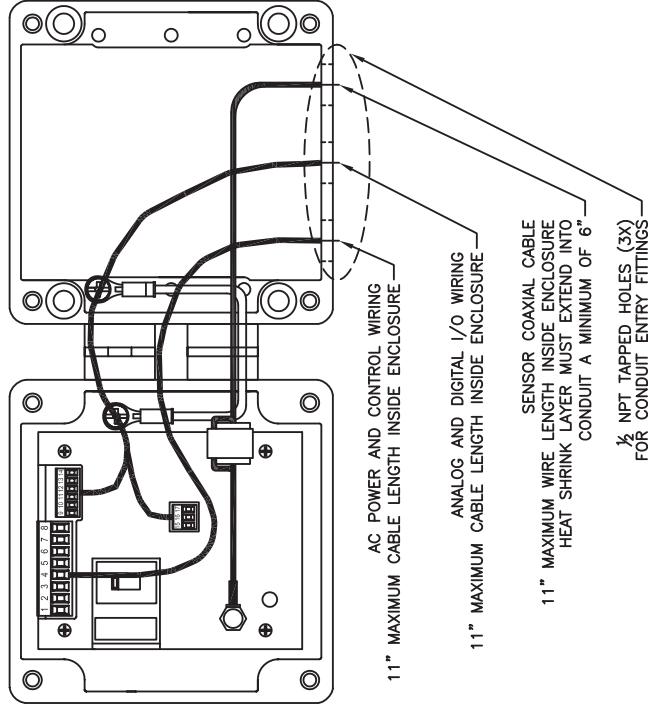

CONFIDENTIAL  
REPRODUCTION IN PART OR WHOLE IS STRICTLY FORBIDDEN. DO NOT DIVULGE TO THIRD PARTIES.

TITLE: PARTICULATE MONITOR  
INSTALLATION DRAWING  
V2.02

ALL DIMENSIONS IN INCHES	SCALE: N/A	DRAWN BY: EC	CHECKED BY: EC	SHEET: 1	OF: 2
TEMPERATURE UNITS: °F	DATE: 8/15/07	DRAWING NO.: 225-1016-01	DO NOT SCALE DRAWING	REV: K	

IMPORTANT INSTALLATION INFORMATION

- HAZARDOUS AREA LOCATIONS: VERIFY REQUIRED CLASS AND DIVISION AGAINST SPECIFICATION LISTED ON THE PROCESS DEVICE TAG.
- DO NOT INSTALL ANY EQUIPMENT THAT IS NOT TAGGED SUITABLE FOR THE AREA CLASSIFICATION.
- BEFORE INSTALLATION VERIFY THE DEVICE IS TAGGED SUITABLE FOR THE REQUIRED AMBIENT TEMPERATURE, PROCESS TEMPERATURE, AND WETTED MATERIALS.
- THIS DEVICE IS NOT DESIGNED FOR USE AS A FUNCTIONAL SAFETY DEVICE. THE DEVICE MUST NOT BE USED AS PART OF OR AS AN INPUT TO A SAFETY SYSTEM.
- ADHERE TO NEC, CEC, NEMA, NFPA, OSHA INSTALLATION AND MAINTENANCE GUIDELINES AND ALL APPLICABLE LOCAL CODES.
- INSTALLATION AND SERVICE MUST BE PERFORMED BY QUALIFIED PERSONNEL WHILE POWER IS DISCONNECTED AND THE PROCESS IS OFF.

WARNING: SUBSTITUTION OF COMPONENTS MAY IMPAIR INTRINSIC SAFETY

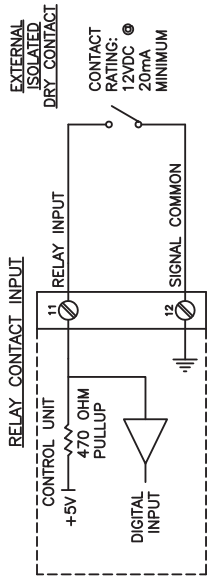

WARNING: DO NOT APPLY EXTERNAL AC OR DC VOLTAGE TO RELAY INPUT OR SIGNAL COMMON TERMINALS. DAMAGE TO CONTROL UNIT MAY OCCUR. AN ISOLATED DRY CONTACT OR SWITCH SHOULD BE USED. SEE NOTE 8.

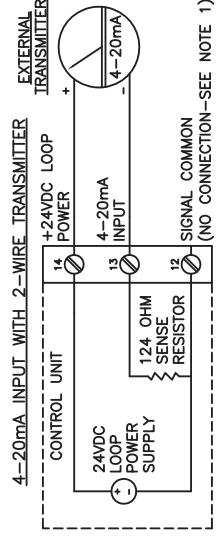

(NO CONNECTION—SEE NOTE 1)

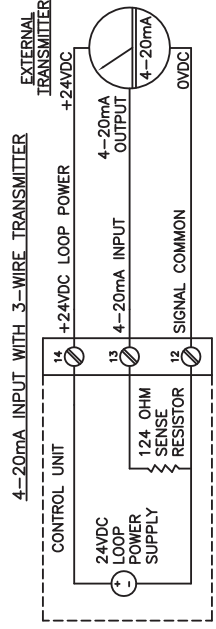
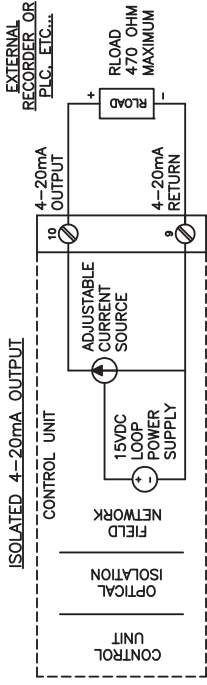

ISOLATED RS-485 NETWORK

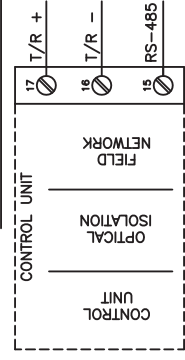

HAZARDOUS AREA INSTALLATIONS:

- HAZARDOUS AREA CONTROL DRAWING 225-1005 MUST BE FOLLOWED FOR PROPER INSTALLATION.
- THE CONTROL UNIT MAY ONLY BE LOCATED IN ORDINARY LOCATIONS (NON-HAZARDOUS SAFE AREAS).
- DO NOT LOCATE THE CONTROL UNIT IN A HAZARDOUS AREA UNLESS IT IS INSIDE AN APPROPRIATELY RATED EXPLOSION-PROOF OR PURGED ENCLOSURE AND SUPPLIED AS PART OF AN APPROVED HAZARDOUS AREA SYSTEM WITH APPROVED CONTROL UNIT AND APPROVED SENSOR ASSEMBLY.

SAFETY:

- DISCONNECT ALL POWER TO THE CONTROL UNIT BEFORE OPENING THE ENCLOSURE.
- ELECTRICAL (ADHERE TO THE NEC AND ALL LOCAL CODES FOR SAFETY)
  - PROPER EARTH GROUND CONNECTIONS MUST BE MADE TO THE SPECIFIED TERMINALS.
  - ALL WIRING MUST BE ENCLOSED IN GROUNDED, METAL CONDUIT. ALL POWER WIRING MUST BE 600V MINIMUM.
  - USE SEPARATE CONDUIT FOR POWER, CONTROL I/O, ANALOG I/O, COMMUNICATIONS WIRING AND ADHERE TO PROPER SPACING AND ROUTING.
  - ANALOG I/O AND COMMUNICATIONS WIRING MUST CROSS POWER AND CONTROL I/O WIRING AT RIGHT ANGLES.
  - ROUTE WIRING AND SENSORS AWAY FROM SOURCES OF INDUCTIVE ENERGY AND INSTALL SURGE SUPPRESSION WHERE APPROPRIATE.
  - REFER TO IEEE STANDARD 518-1982 AND 1100-1992 FOR FURTHER GUIDELINES.
  - GROUNDING - SEE DIAGRAM AT RIGHT.
  - RELAY CONTACT INPUT IS NON-ISOLATED. AN ISOLATING CONTROL RELAY SHOULD BE USED IF THE SIGNAL WIRING ORIGINATES OR IS LOCATED NEAR SOURCES OF ELECTRICAL INTERFERENCE.
- ANALOG AND COMMUNICATIONS
  - 4-20mA CABLE: 250V MINIMUM, 22AWG, STRANDED, SHIELDED TWISTED PAIR, BELDEN 88761 OR EQUIVALENT.
  - RS-485 CABLE: 250V MINIMUM, 22AWG, STRANDED, SHIELDED TWISTED PAIR, 120 OHM IMPEDANCE, BELDEN 3106A, 3107A OR EQUIVALENT.
  - RS-485 NETWORK MUST BE WIRED POINT-TO-POINT IN SERIES CONFIGURATION, NOT STAR OR TRUNK/DROP.
  - INSTALL 120 OHM, ½ WATT TERMINATING RESISTOR BETWEEN TERMINALS TX/RX (+) AND TX/RX (-) IF THIS CONTROL UNIT IS LOCATED AT NETWORK END.
- DISCRETE RELAY OUTPUTS
  - FORM A (SPST) CONTACT, RATED 5A@240VAC. RESISTIVE. AN 8 AMP (MAX) FUSE IN SERIES WITH EACH LOAD IS REQUIRED.

REV	DESCRIPTION
E	ENCLOSURE DIMENSIONS UPDATE
F	TITLE BLOCK AND NOTES UPDATE
G	CHANGED TO 50mA FUSE
H	COMBINE ORDINARY AND HAZARDOUS AREAS
I	UPDATED TEXT AND GROUND SYMBOLS
J	UPDATED TITLE BLOCK
K	UPDATE TITLE BLOCK

VI.5

OPTIONAL RS-485 TERMINAL BLOCK LEGEND

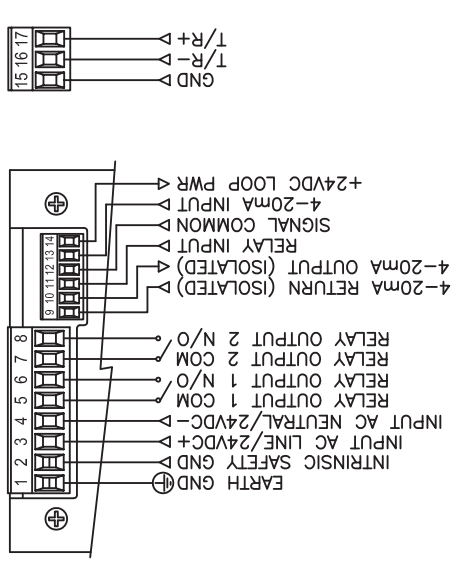

GROUNDING FOR NON-HAZARDOUS INSTALLATION

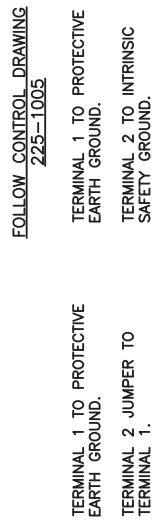

TERMINAL 1 TO PROTECTIVE EARTH GROUND.  
TERMINAL 2 TO INTRINSIC SAFETY GROUND.

GROUNDING FOR HAZARDOUS INSTALLATIONS

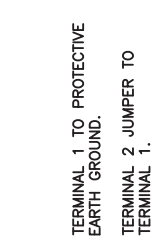

TERMINAL 1 TO PROTECTIVE EARTH GROUND.  
TERMINAL 2 TO INTRINSIC SAFETY GROUND.

REPRODUCTION IN PART OR WHOLE IS STRICTLY FORBIDDEN. DO NOT DIVULGE TO THIRD PARTIES.	
ALL DIMENSIONS IN INCHES	TITLE: PARTICULATE MONITOR
TERMINAL BLOCKS	INSTALLATION DRAWING
TERMINAL BLOCKS	V2.02
X.001 = ±0.01	
X.002 = ±0.005	
ANGLES = ±0.5°	
SCALE: 1" = 1"	DRAWN BY: EC
DATE: 8/15/07	CHECKED BY: EC
DO NOT SCALE DRAWING	SHEET 2 OF 2
	REV: K

IMPORTANT INSTALLATION INFORMATION

REV	DESCRIPTION
B	TITLE BLOCK AND TEXT UPDATES
C	COMBINE ORDINARY AND HAZARDOUS AREAS
D	UPDATED TEXT
E	ADD HIGH TEMP/PRESSURE ON SECOND TEST
F	UPDATED TITLE BLOCK
G	REMOVED ALL HT INFORMATION
H	UPDATE TITLE BLOCK

VI.5

- HAZARDOUS AREA LOCATIONS: VERIFY REQUIRED CLASS AND DIVISION AGAINST SPECIFICATION LISTED ON THE PROCESS DEVICE TAG.
- DO NOT INSTALL ANY EQUIPMENT THAT IS NOT TAGGED SUITABLE FOR THE AREA CLASSIFICATION.
- BEFORE INSTALLATION VERIFY THE DEVICE IS TAGGED SUITABLE FOR THE REQUIRED AMBIENT TEMPERATURE, PROCESS TEMPERATURE, PROCESS PRESSURE, AND WETTED MATERIALS.
- THIS DEVICE IS NOT DESIGNED FOR USE AS A FUNCTIONAL SAFETY DEVICE. THE DEVICE MUST NOT BE USED AS PART OF OR AS AN INPUT TO A SAFETY SYSTEM.
- ADHERE TO NEC, CEC, NEMA, NFPA, OSHA INSTALLATION AND MAINTENANCE GUIDELINES AND ALL APPLICABLE LOCAL CODES.
- INSTALLATION AND SERVICE MUST BE PERFORMED BY QUALIFIED PERSONNEL WHILE POWER IS DISCONNECTED AND THE PROCESS IS OFF.

**HAZARDOUS AREA INSTALLATIONS:**

- HAZARDOUS AREA CONTROL DRAWING 225-1005 MUST BE FOLLOWED FOR PROPER INSTALLATION.
- HAZARDOUS AREA CONTROL DRAWING 225-1005 MUST BE REFERRED TO FOR THE REFERENCE MANUAL FOR FULL DETAIL.
- DIRECT CONNECTION OF THE SENSOR GROUND CABLE TO EARTH GROUNDING DUCT IS REQUIRED. GROUND CABLE IS TO REMAIN CONNECTED WHEN THE SENSOR IS TEMPORARILY REMOVED FROM THE PROCESS. LEAVE SUFFICIENT GROUND CABLE SERVICE LOOP FOR REMOVAL OF THE SENSOR FROM THE PROCESS.

**PARTICULATE SENSOR INSTALLATION:**

- SEE DIAGRAM AND REFER TO MANUAL FOR ADDITIONAL RECOMMENDATIONS ON SENSOR LOCATION.
- WELD PROCESS FITTING TO PIPE/DUCT AS SHOWN, SLIGHTLY PROTRUDING INTO PIPE/DUCT. DO NOT FACE WELD. WELD ALL AROUND FOR AIR AND WATER TIGHT SEAL. WELD IN CENTER OF PIPE/DUCT AND PERPENDICULAR TO FLOW.
- WHEN MOUNTING THE SENSOR IN A STACK, DO NOT PLACE IN A LOCATION THAT MAY ALLOW RAIN OR AMBIENT DUST TO FLOW OVER PROBE, INCLUDING WHEN THE PROCESS AIRFLOW IS OFF. THE SENSOR SHOULD BE LOCATED NO CLOSER THAN FIVE DIAMETERS FROM THE END OF THE STACK TO PROVIDE ELECTRICAL SHIELDING.
- WELD TO SURFACE CAPABLE OF SUPPORTING AT LEAST FIVE TIMES THE SENSOR WEIGHT.

**PARTICULATE SENSOR COAXIAL CABLE INSTALLATION:**

- DO NOT SUBSTITUTE AND DO NOT ROUTE WITH ANY OTHER CABLE, EXCEPT FOR OTHER PARTICULATE SENSOR CABLES.
- MAINTAIN SEPARATION OF 18 INCHES (0.5 METER) FROM OTHER CABLING AND INDUCTIVE ENERGY SOURCES. CROSS CONDUCTORS AT RIGHT ANGLES.
- ALL CABLES MUST BE ENCLOSED IN GROUNDING, METAL CONDUIT.
- INSTALL A SERVICE LOOP OF SHIELDED FLEX CONDUIT AT THE SENSOR-END THAT IS 1 TO 2 TIMES THE SENSOR PROBE LENGTH.

WARNING: SUBSTITUTION OF COMPONENTS MAY IMPAIR INTRINSIC SAFETY

TYPICAL MOUNTING EXAMPLE

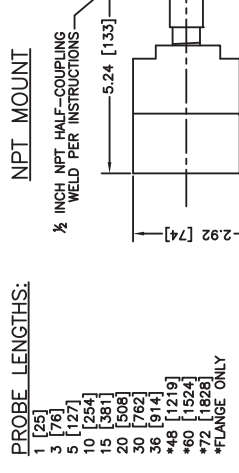

- PROBE LENGTHS:**
- 1 [26]
  - 3 [76]
  - 5 [127]
  - 10 [254]
  - 15 [381]
  - 20 [508]
  - 30 [762]
  - 36 [914]
  - \*48 [1219]
  - \*60 [1524]
  - \*72 [1828]
  - \*FLANGE ONLY

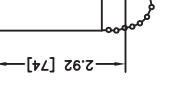
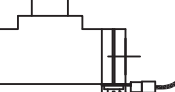
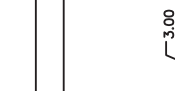
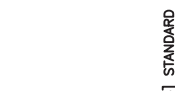
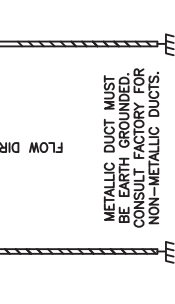
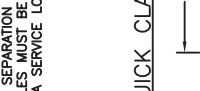
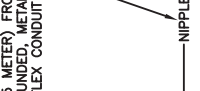
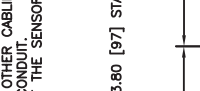
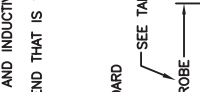
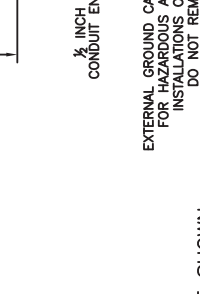
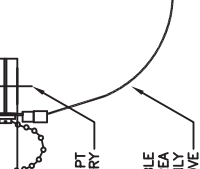
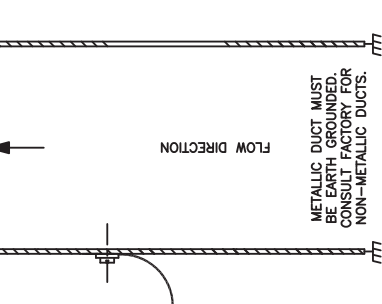

ALL DIMENSIONS IN INCHES		DRAWN BY: EC		SHEET 1 OF 1	
TOLERANCES UNLESS OTHERWISE SPECIFIED		CHECKED BY: EC		REV: H	
X.25 = ±0.01		DATE: 8/15/07		DRAWING NO. 225-1014-06	
X.50 = ±0.02		SCALE: N/A		DO NOT SCALE DRAWING	
X.75 = ±0.03		DATE: 8/15/07		DRAWING NO. 225-1014-06	
X.100 = ±0.005		DATE: 8/15/07		DRAWING NO. 225-1014-06	
X.125 = ±0.005		DATE: 8/15/07		DRAWING NO. 225-1014-06	
X.150 = ±0.005		DATE: 8/15/07		DRAWING NO. 225-1014-06	
X.1875 = ±0.005		DATE: 8/15/07		DRAWING NO. 225-1014-06	
X.250 = ±0.005		DATE: 8/15/07		DRAWING NO. 225-1014-06	
X.3125 = ±0.005		DATE: 8/15/07		DRAWING NO. 225-1014-06	
X.375 = ±0.005		DATE: 8/15/07		DRAWING NO. 225-1014-06	
X.500 = ±0.005		DATE: 8/15/07		DRAWING NO. 225-1014-06	
X.625 = ±0.005		DATE: 8/15/07		DRAWING NO. 225-1014-06	
X.750 = ±0.005		DATE: 8/15/07		DRAWING NO. 225-1014-06	
X.875 = ±0.005		DATE: 8/15/07		DRAWING NO. 225-1014-06	
X.1000 = ±0.005		DATE: 8/15/07		DRAWING NO. 225-1014-06	
X.1250 = ±0.005		DATE: 8/15/07		DRAWING NO. 225-1014-06	
X.1500 = ±0.005		DATE: 8/15/07		DRAWING NO. 225-1014-06	
X.1875 = ±0.005		DATE: 8/15/07		DRAWING NO. 225-1014-06	
X.2500 = ±0.005		DATE: 8/15/07		DRAWING NO. 225-1014-06	
X.3125 = ±0.005		DATE: 8/15/07		DRAWING NO. 225-1014-06	
X.3750 = ±0.005		DATE: 8/15/07		DRAWING NO. 225-1014-06	
X.5000 = ±0.005		DATE: 8/15/07		DRAWING NO. 225-1014-06	
X.6250 = ±0.005		DATE: 8/15/07		DRAWING NO. 225-1014-06	
X.7500 = ±0.005		DATE: 8/15/07		DRAWING NO. 225-1014-06	
X.8750 = ±0.005		DATE: 8/15/07		DRAWING NO. 225-1014-06	
X.10000 = ±0.005		DATE: 8/15/07		DRAWING NO. 225-1014-06	

REPRODUCTION IN PART OR WHOLE IS STRICTLY FORBIDDEN. DO NOT DIVULGE TO THIRD PARTIES.

TITLE: PARTICULATE FLOW SENSOR INSTALLATION DRAWING V2.02

CONFIDENTIAL

IMPORTANT INSTALLATION INFORMATION

REV	DESCRIPTION
A	INITIAL RELEASE
B	UPDATE SENSOR MOUNT AND TITLE BLOCK
C	UPDATE MAIN TERMINAL BLOCK, SEPARATE GROUNDS
D	UPDATE GROUNDING NOTES
E	TITLE BLOCK AND NOTES UPDATE
F	UPDATED TITLE BLOCK
G	UPDATE TITLE BLOCK

- HAZARDOUS AREA LOCATIONS: VERIFY REQUIRED CLASS AND DIVISION AGAINST SPECIFICATION LISTED ON THE PROCESS DEVICE TAG.
- DO NOT INSTALL ANY EQUIPMENT THAT IS NOT TAGGED SUITABLE FOR THE AREA CLASSIFICATION.
- BEFORE INSTALLATION VERIFY THE DEVICE IS TAGGED SUITABLE FOR THE REQUIRED AMBIENT TEMPERATURE, PROCESS TEMPERATURE, PROCESS PRESSURE, AND WETTED MATERIALS.
- THIS DEVICE IS NOT DESIGNED FOR USE AS A FUNCTIONAL SAFETY DEVICE. THE DEVICE MUST NOT BE USED AS PART OF OR AS AN INPUT TO A SAFETY SYSTEM.
- ADHERE TO NEC, CEC, NEMA, NFPA, OSHA INSTALLATION AND MAINTENANCE GUIDELINES AND ALL APPLICABLE LOCAL CODES.
- INSTALLATION AND SERVICE MUST BE PERFORMED BY QUALIFIED PERSONNEL WHILE POWER IS DISCONNECTED AND THE PROCESS IS OFF.

VI.5

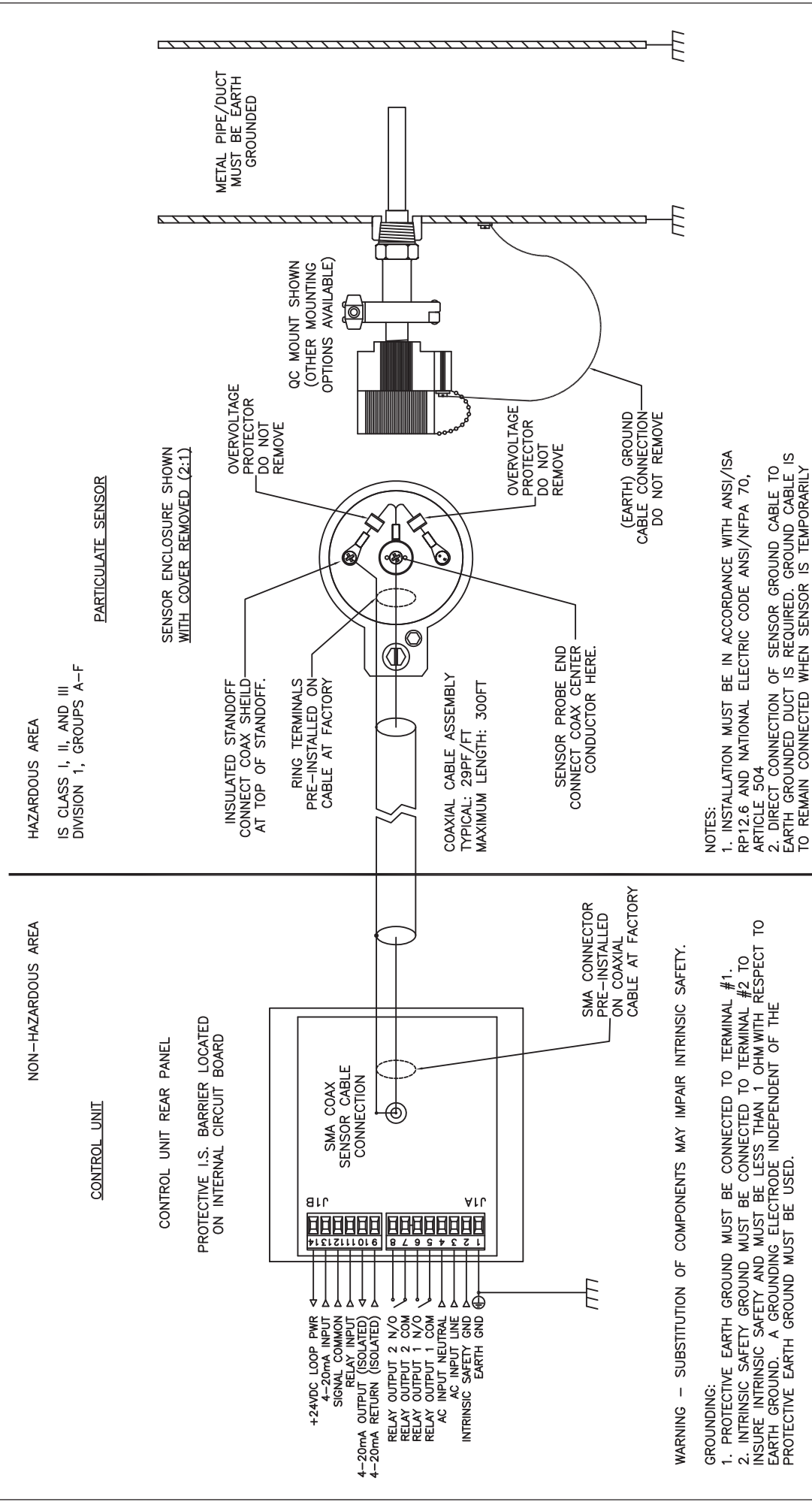

- NOTES:
- INSTALLATION MUST BE IN ACCORDANCE WITH ANSI/ISA RP12.6 AND NATIONAL ELECTRIC CODE ANSI/NFPA 70, ARTICLE 504
  - DIRECT CONNECTION OF SENSOR GROUND CABLE TO EARTH GROUNDED DUCT IS REQUIRED. GROUND CABLE IS TO REMAIN CONNECTED WHEN SENSOR IS TEMPORARILY REMOVED FROM PROCESS
  - LEAVE SUFFICIENT GROUND CABLE SERVICE LOOP FOR REMOVAL OF SENSOR FROM PROCESS.

WARNING - SUBSTITUTION OF COMPONENTS MAY IMPAIR INTRINSIC SAFETY.

- GROUNDING:
- PROTECTIVE EARTH GROUND MUST BE CONNECTED TO TERMINAL #1.
  - INTRINSIC SAFETY GROUND MUST BE CONNECTED TO TERMINAL #2 TO INSURE INTRINSIC SAFETY AND MUST BE LESS THAN 1 OHM WITH RESPECT TO EARTH GROUND. A GROUNDING ELECTRODE INDEPENDENT OF THE PROTECTIVE EARTH GROUND MUST BE USED.

- NOTES:
- FOR CONTROL UNITS WITH METALLIC ENCLOSURES: THE ENCLOSURE COVER MUST BE BONDED TO THE ENCLOSURE BASE WITH THE SUPPLIED GROUND JUMPER WIRE - DO NOT REMOVE.
  - ALL WIRING MUST BE RATED AT 250V MINIMUM.
  - AC INPUT - SELECTOR SWITCH IN 115V POSITION: 97-132V~, 47-63HZ
  - AC INPUT - SELECTOR SWITCH IN 250V POSITION: 195-264V~, 47-63HZ

REPRODUCTION IN PART OR WHOLE IS STRICTLY FORBIDDEN. DO NOT DIVULGE TO THIRD PARTIES.	
ALL DIMENSIONS IN INCHES	TITLE: PARTICULATE MONITOR HAZARDOUS AREA CONTROL DRAWING V2.02
TEMPERATURE UNITS: °F	SCALE: N/A
LENGTHS: INCHES	DRAWN BY: EC
WEIGHTS: LBS	CHECKED BY: EC
ANGLES: °	DATE: 8/15/07
DO NOT SCALE DRAWING	DRAWING NO. 225-1005
	SHEET 1 OF 1
	REV. G

IMPORTANT INSTALLATION INFORMATION

REV	DESCRIPTION
A	INITIAL RELEASE
B	UPDATE TITLE BLOCK

VI.5

- HAZARDOUS AREA LOCATIONS: VERIFY REQUIRED CLASS AND DIVISION AGAINST SPECIFICATION LISTED ON THE PROCESS DEVICE TAG.
- DO NOT INSTALL ANY EQUIPMENT THAT IS NOT TAGGED SUITABLE FOR THE AREA CLASSIFICATION.
- BEFORE INSTALLATION VERIFY THE DEVICE IS TAGGED SUITABLE FOR THE REQUIRED AMBIENT TEMPERATURE, PROCESS TEMPERATURE, PROCESS PRESSURE, AND WETTED MATERIALS.
- THIS DEVICE IS NOT DESIGNED FOR USE AS A FUNCTIONAL SAFETY DEVICE. THE DEVICE MUST NOT BE USED AS PART OF OR AS AN INPUT TO A SAFETY SYSTEM.
- ADHERE TO NEC, CEC, NEMA, NFPA, OSHA INSTALLATION AND MAINTENANCE GUIDELINES AND ALL APPLICABLE LOCAL CODES.
- INSTALLATION AND SERVICE MUST BE PERFORMED BY QUALIFIED PERSONNEL WHILE POWER IS DISCONNECTED AND THE PROCESS IS OFF.

**HAZARDOUS AREA INSTALLATIONS:**

- HAZARDOUS AREA CONTROL DRAWING 225-1005 MUST BE FOLLOWED FOR PROPER INSTALLATION.
- MAXIMUM AMBIENT TEMPERATURE OF THE SENSOR ENCLOSURE MUST NOT BE EXCEEDED. REFERENCE MANUAL FOR FULL DETAIL.
- DIRECT CONNECTION OF THE SENSOR GROUND CABLE TO EARTH GROUNDED DUCT IS REQUIRED. GROUND CABLE IS TO REMAIN CONNECTED WHEN THE SENSOR IS TEMPORARILY REMOVED FROM THE PROCESS. LEAVE SUFFICIENT GROUND CABLE SERVICE LOOP FOR REMOVAL OF THE SENSOR FROM THE PROCESS.

WARNING: SUBSTITUTION OF COMPONENTS MAY IMPAIR INTRINSIC SAFETY

PROCESS MOUNT FOR FLANGE SENSORS

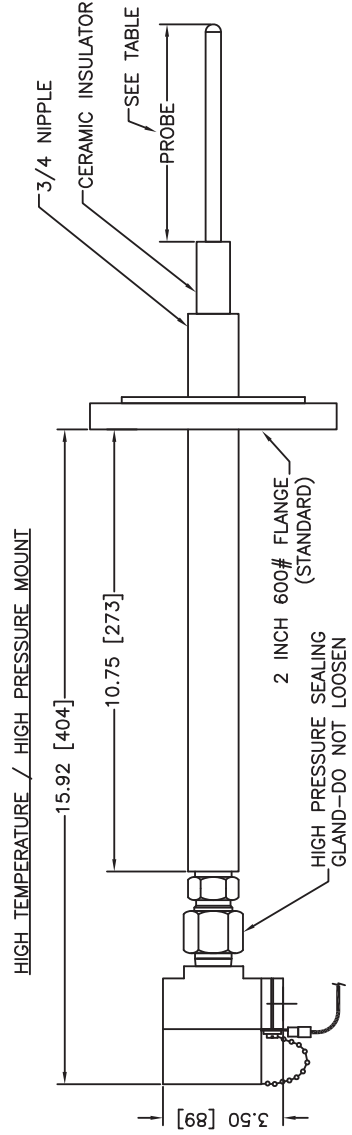
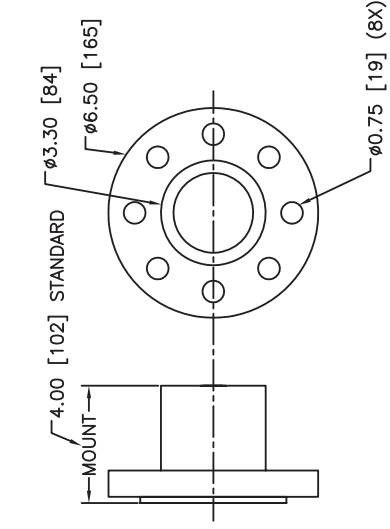

DUST COLLECTOR: TYPICAL SENSOR LOCATIONS

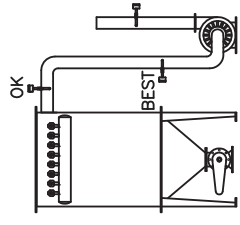

ENCLOSURE SHOWN WITH COVER REMOVED

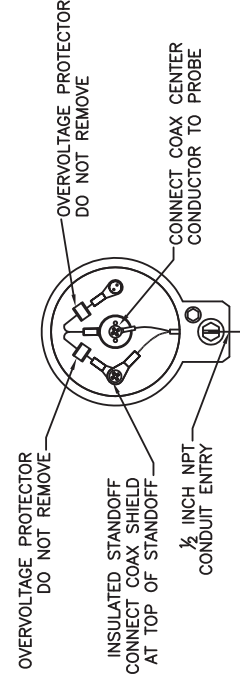

PARTICULATE SENSOR INSTALLATION:

- SEE DIAGRAM AND REFER TO MANUAL FOR ADDITIONAL RECOMMENDATIONS ON SENSOR LOCATION.
- WELD PROCESS FITTING TO PIPE/DUCT AS SHOWN, SLIGHTLY PROTRUDING INTO PIPE/DUCT. DO NOT FACE WELD. WELD ALL AROUND FOR AIR AND WATER TIGHT SEAL. WELD IN CENTER OF PIPE/DUCT AND PERPENDICULAR TO FLOW.
- WHEN MOUNTING THE SENSOR IN A STACK, DO NOT PLACE IN A LOCATION THAT MAY ALLOW RAIN OR AMBIENT DUST TO FLOW OVER PROBE, INCLUDING WHEN THE PROCESS AIRFLOW IS OFF. THE SENSOR SHOULD BE LOCATED NO CLOSER THAN FIVE DIAMETERS FROM THE END OF THE STACK TO PROVIDE ELECTRICAL SHIELDING.
- WELD TO SURFACE CAPABLE OF SUPPORTING AT LEAST FIVE TIMES THE SENSOR WEIGHT.
- EXTERNAL INSULATION AROUND SENSOR MOUNT SHOULD BE REPLACED AFTER INSTALLATION IS COMPLETE TO PREVENT CONDENSATION OF PROCESS GAS.
- SENSOR ENCLOSURE TEMPERATURE MUST NOT EXCEED 185F (85C).

PARTICULATE SENSOR COAXIAL CABLE INSTALLATION:

- DO NOT SUBSTITUTE AND DO NOT ROUTE WITH ANY OTHER CABLE, EXCEPT FOR OTHER PARTICULATE SENSOR CABLES.
- MAINTAIN SEPARATION OF 18 INCHES (0.5 METER) FROM OTHER CABLING AND INDUCTIVE ENERGY SOURCES. CROSS CONDUCTORS AT RIGHT ANGLES.
- ALL CABLES MUST BE ENCLOSED IN GROUNDED, METAL CONDUIT.
- INSTALL A SERVICE LOOP OF SHIELDED FLEX CONDUIT AT THE SENSOR-END THAT IS 1 TO 2 TIMES THE SENSOR PROBE LENGTH.

HIGH TEMPERATURE AND PRESSURE FLANGE ORIENTATION

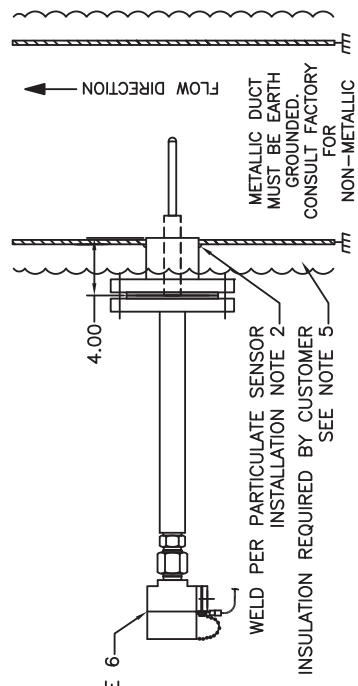

PROBE LENGTHS:

10	[254]
15	[381]
20	[508]
30	[762]
36	[914]
*48	[1219]
*60	[1524]
*72	[1828]
*FLANGE ONLY	

ALL DIMENSIONS IN INCHES		TITLE: HIGH TEMP / HIGH PRESSURE PARTICULATE FLOW SENSOR INSTALLATION DRAWING	
TOLERANCES UNLESS OTHERWISE SPECIFIED		V2.02	
X.001 = ±0.01		SCALE: N/A	DRAWN BY: EC
ANGLES = ±0.5		CHECKED BY: EC	SHEET 1 OF 1
DATE: 8/15/07	DRAWING NO. 225-1036	REV: B	

REPRODUCTION IN PART OR WHOLE IS STRICTLY FORBIDDEN. DO NOT DIVULGE TO THIRD PARTIES.

CONFIDENTIAL